

KIBIRA LED BOLLARDS IP65

Cover

Die cast aluminium

Body

Die cast aluminium

die cast aluminium bottom and connection box.

Gaskets

Silicone

Diffusers

4 mm Tempered Glass (Aluminium Cover)

Screws

316L Stainless steel

Glands

2 x PG 13.5

Recessing Tube

Polyamide 6

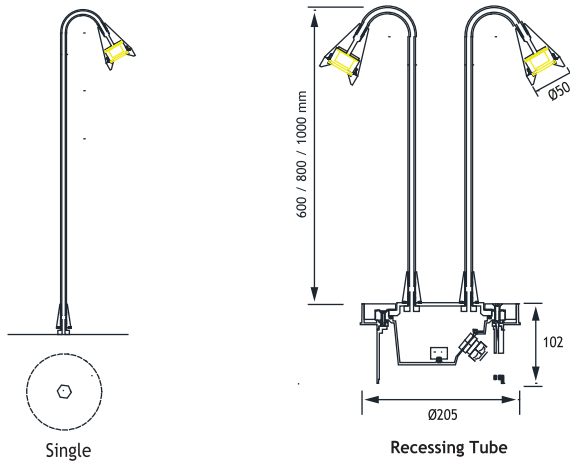

Led : LEDs (1W or 3W)
Voltage : 240 VAC with External driver
 (12-24 VDC on request)
Diffuser : >80

800 mm 700 mA (3W) LED	Code No Single
☰ Natural White 4000 K	191112

LEDs

Only highest quality LEDs such as Cree or Toplite are used in production allowing for maximum lumen output and maximum lifetime. Most LEDs run on 350mA or 700mA depending on how much light output is required. The white color temperature binning is 200K at most, and always on the same x,y coordinates on the CIE diagram in accordance with Energy Star. This ensures consistent supply of the same color temperature over time. As LEDs are constantly developing and becoming more efficient, lumen output given in this catalogue are current as of March 2020. At 2700K, 3000K, and 4000K LED lumen output per led is 110lm; at 6000K the lumen output per led is 125lm. Total Lighting Output as printed in this catalogue is the actual light output of the entire fixture. The minimum CRI of the LEDs used is 85 with a majority of products over 90.