

SANTOS 4 RECESSED DRIVE OVER FIXTURES

Load 10 kN | Class I IP67 IK10

EMFA's Santos flush mounted series is specially designed to deliver low-glare lighting to facades, columns, monuments and trees with minimal installation depth and narrow trim. The fixture is made of a combination of 316L stainless steel and die cast aluminium. A shield above the lamp reduces the glare of the metal halide lamps. A mirror finish reflector allows for a narrow to wide beam light output. An anti-slip glass is available upon request.

Cover

316L Stainless steel

Body

Die cast aluminium or aluminium profile with die cast aluminium bottom and connection box

Gaskets

Silicone

Diffusers

8 mm Tempered Glass

Screws

316L Stainless steel

Glands

2 x PG 13.5

Recessing Tube

Polyamide 6



Led : COB LED - Adjustable

Reflector : 10°, 23°, 38° Aluminium-Coated Polycarbonate Reflector

Diffuser : Clear Glass

Gear : 240V Non-Dimmable Driver (1-10V Dimmable Driver & DALI Driver available on request)

Temp : 42°C

Vertical Tilt : 30°

METAL HALIDE

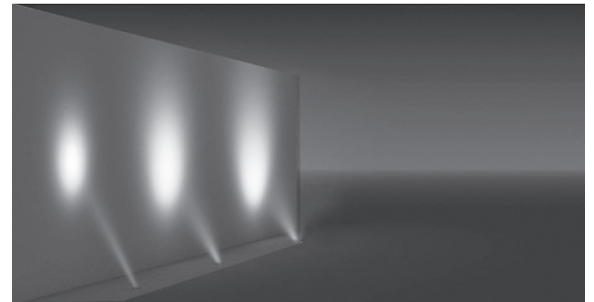
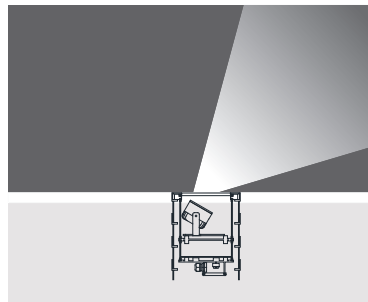

METAL HALIDE	Code No
70W	550131

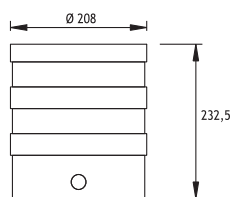
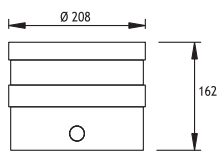

Mounting Feature

Provide at least 30 cm of drainage gravel to avoid the accumulation of water under the fixture. To make the fixture drive over, the recessing tube should be mounted flush to the ground.

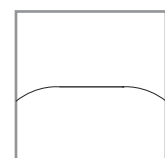
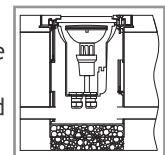

Correct

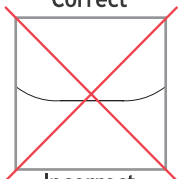

Incorrect

When mounting the fixture on uneven surfaces, place so that the water does not accumulate on the surface of the fixture.