

KNIDOS RECESSED DRIVE OVER FIXTURES

Load 20 kN | Class I IP67 IK10

EMFA's Knidos series consists of a range of LED, metal halide, and fluorescent sources to deliver the desired light effect to facades, columns, monuments and trees. The fixture is made of a combination of 316L stainless steel and glass reinforced polyester, which makes it completely resistant to corrosion. The sturdy fixture allows loads up to 20kN and IK 10. The LEDs used come in 3 different tones of white, as well as blue, red, green, and amber. An anti-slip glass is available upon request.

Adjustable Asymmetrical LEDs

In this series EMFA is introducing its first adjustable asymmetric LED unit. The LEDs can be internally adjusted up to 40 degree to give the desired light output to facades, columns, monuments, and trees without losing light to the sky. The Knidos is large enough, and has enough surface area so that at an ambient temperature of 50° C, 9 LEDs can be operated at 350 mA (9W).

- Lampholder : G12 Adjustable ± 35°
- Reflector : 30°
- Diffuser : Clear Glass
- Temp : 102°C

“Customization” is EMFA’s standard

EMFA offers many combinations for each fixture, as all fixtures are made in house. A combination of 2 finishes of stainless steel, 8 LED colors, 2 wattages, and 5 or more lenses and reflectors are available to make the fixture suitable for the required application. This is done without increasing lead-time and is available for large as well as small quantities.

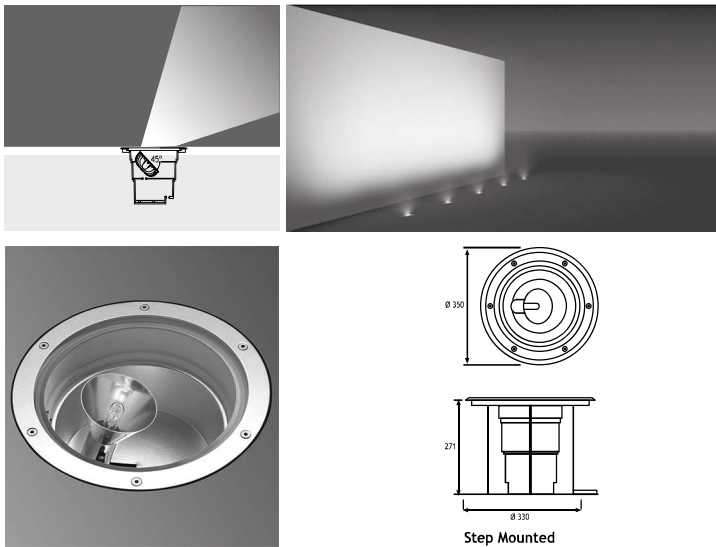

METAL HALIDE 70W	Code No
Step Mounted	254201

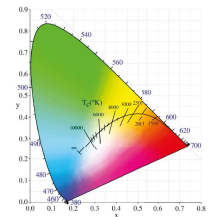

LEDs

Only highest quality LEDs such as Cree or Toplite are used in production allowing for maximum lumen output and maximum lifetime. Most LEDs run on 350mA or 700mA depending on how much light output is required. The white color temperature binning is 200K at most, and always on the same x,y coordinates on the CIE diagram in accordance with Energy Star. This ensures consistent supply of the same color temperature over time. As LEDs are constantly developing and becoming more efficient, lumen output given in this catalogue are current as of March 2020. At 2700K, 3000K, and 4000K LED lumen output per led is 110lm; at 6000K the lumen output per led is 125lm. Total Lighting Output as printed in this catalogue is the actual light output of the entire fixture. The minimum CRI of the LEDs used is 85 with a majority of products over 90.

Thermal Management

All fixtures are designed to withstand ambient temperatures of at least 50° C. The LEDs are mounted on metal core pcbs, which are mounted the aluminium body of the fixture so that the entire fixture acts as a heat sink. Extensive testing is performed in EMFA's laboratory to ensure these values are maintained so that the lifetime of the LED is not compromised.

Accessories:

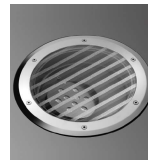

Anti-slip Glass

Please contact for this option.