

DARA LED SPOTS

Class I IP65 IK08

Available in any of these RAL colors

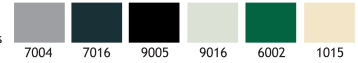

The Dara Spot series has an LED source to deliver the desired light effect to facades, columns, bridges, monuments, signs, and trees. The series is made of die cast aluminium and painted with electrostatic powder paint. 6 standard RAL colors can be chosen from to adapt the spots to their environment (grey, anthracite, black, white, green and beige). The spots can be mounted on surfaces, in the ground or concrete with a picket, or on a pole with the addition of a simple adaptor. Once installed, the special joint system allows for 100° horizontal and 180° vertical adjustment.

The LEDs used come in 3 different tones of white (2700K, 3000K, 4000K) Several lenses from 10 to 30 degrees are available to choose from to achieve the desired light effect.

Body

Die cast aluminium

Paint

Electrostatic powder

Pipe

Aluminium Profile

Gaskets

Silicone

Diffusers

Tempered Glass

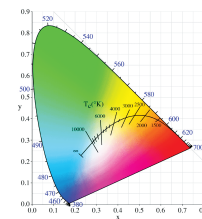
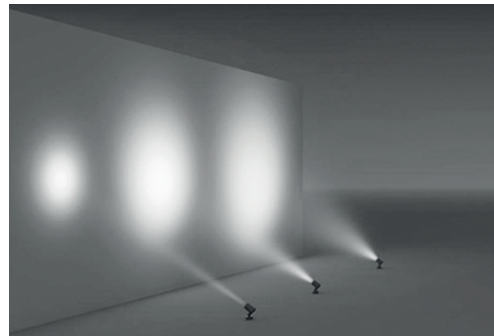
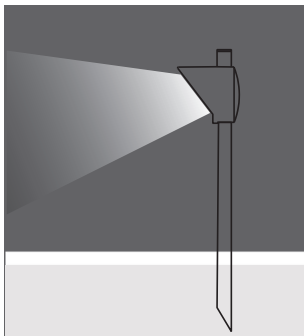
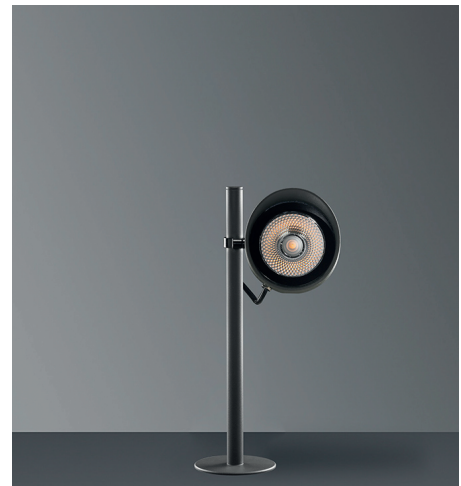

LEDs

Only highest quality LEDs such as Cree or Toplite are used in production allowing for maximum lumen output and maximum lifetime. Most LEDs run on 350mA or 700mA depending on how much light output is required. The white color temperature binning is 200K at most, and always on the same x,y coordinates on the CIE diagram in accordance with Energy Star. This ensures consistent supply of the same color temperature over time. As LEDs are constantly developing and becoming more efficient, lumen output given in this catalogue are current as of March 2020. At 2700K, 3000K, and 4000K LED lumen output per led is 110lm; at 6000K the lumen output per led is 125lm. Total Lighting Output as printed in this catalogue is the actual light output of the entire fixture. The minimum CRI of the LEDs used is 85 with a majority of products over 90.

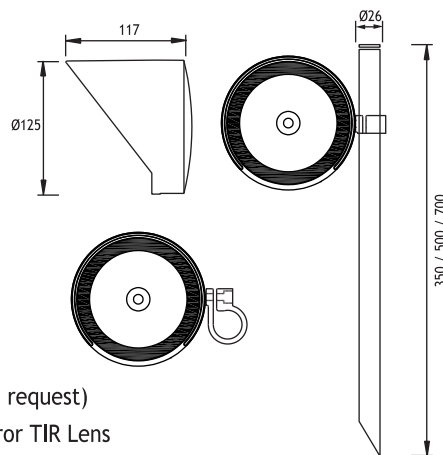

- Voltage** : 240V A.C
(24V AC or DC on request)
- Lens** : 10°, 20°, 30° Mirror TIR Lens
- Diffuser** : Clear Glass 3 mm (Frosted Glass on request)
- Cable** : Potted 2 m 2x0,75 H03 VV-F

1 x 350 mA (16 W) COB LED		Total Lighting Output	Code No	
700 mm	☀ Warm White	2700 / 3000 K	1520 lm	557201

Thermal Management

All fixtures are designed to withstand ambient temperatures of at least 50°C. The LEDs are mounted on metal core pcbs, which are mounted the aluminium body of the fixture so that the entire fixture acts as a heat sink. Extensive testing is performed in EMFA's laboratory to ensure these values are maintained so that the lifetime of the LED is not compromised.