

ATLANTIS 1 UNDERWATER RECESSED LED FIXTURES

Class III IP68 IK10

The Atlantis Underwater series is specially designed to light pools, fountains and water features with high power LED light. The series is made of 316L stainless steel to withstand salt water and chlorine. Standard finish is polished stainless steel to avoid collection of dirt and algae, but a brushed finish is also possible. The series comes as recessed, surface mount or spots. The spots are heavy duty with stainless steel brackets for sturdy fixing. The bodies are filled with cast resin and a specially developed potted power cable is used to effectively bond with the cast resin and stop any water ingress. The low voltage electronic LED driver is housed in the base of the fixture. The LEDs used come in 3 different tones of white, as well as blue, red, green, amber or RGB. Several lenses from 6 to 40 degrees are available to choose from to achieve the desired light effect.

Frame	Recessing Tube	Diffusers
316L Stainless Steel	Aluminium	Tempered Glass
Body	Gaskets	Screws
316L Stainless Steel	Silicone	Stainless Steel
		Mounting Brackets
		316L Stainless Steel

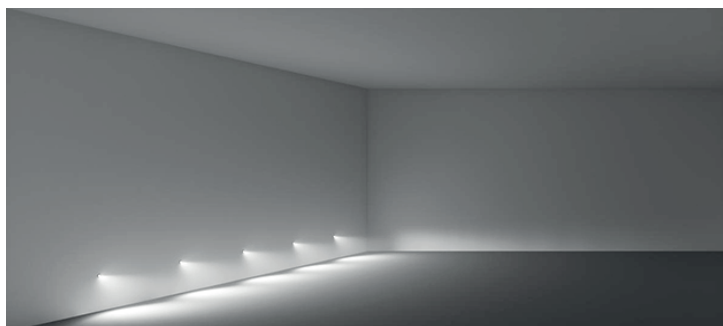
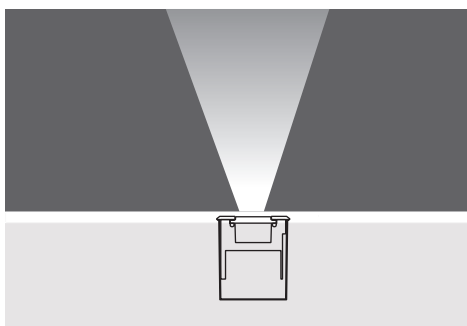

Voltage	: 12V AC or DC (24V AC or DC on request)
Lens	: 10°, 25°, 40°
Diffuser	: 8 mm Clear Glass (Frosted Glass on request)
Cable	: Potted 5 m 2x0,75 H03 VV-F

1 x 350 mA (1 W) LED				
1 x 700 mA (3 W) LED		Total Lighting Output	3W	
		1W	3W	Square
Cool White	6000 K	102 lm	270 lm	421213

Single color LED options upon request are ;
 Blue Amber Green Red

