

BELKIS 5 SPOTS WITH GEARBOX

Class I IP67 IK10

Available in any of these RAL colors

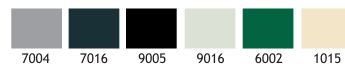

The Belkis Spot series consists of a range of LED, metal halide, fluorescent and halogen sources to deliver the desired light effect to facades, columns, bridges, monuments, signs, and trees. The series is made of die cast aluminium and painted with electrostatic powder paint. 6 standard RAL colors can be chosen from to adapt the spots to their environment (grey, anthracite, black, white, green and beige). The spots can be mounted on surfaces, in the ground or concrete with a picket, or on a pole with the addition of a simple adaptor. Two adaptors are available for two sizes of poles. Once installed, the special joint system allows for 100° horizontal and 180° vertical adjustment. The gearboxes are either filled with cast resin and have a pre-potted cable for IP67, or have a stainless steel cover and cable glands for IP55. The LEDs used come in 3 different tones of white, as well as blue, red, green, amber and RGB. Several lenses from 6 to 40 degrees are available to choose from to achieve the desired the light effect.

Body	Gaskets
Die cast aluminium	Silicone
Paint	Diffusers
Electrostatic powder	Tempered Glass
Gearbox Cover	
Stainless steel	

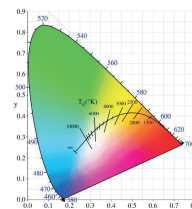
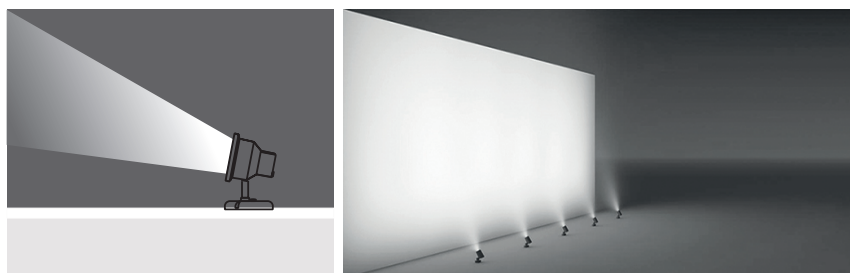

LEDs

Only highest quality LEDs such as Cree or Toplite are used in production allowing for maximum lumen output and maximum lifetime. Most LEDs run on 350mA or 700mA depending on how much light output is required. The white color temperature binning is 200K at most, and always on the same x,y coordinates on the CIE diagram in accordance with Energy Star. This ensures consistent supply of the same color temperature over time. As LEDs are constantly developing and becoming more efficient, lumen output given in this catalogue are current as of March 2020. At 2700K, 3000K, and 4000K LED lumen output per led is 110lm; at 6000K the lumen output per led is 125lm. Total Lighting Output as printed in this catalogue is the actual light output of the entire fixture. The minimum CRI of the LEDs used is 85 with a majority of products over 90.

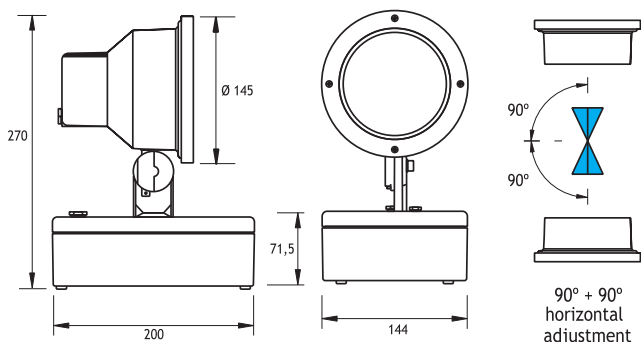

Picket



Code No: 953805

Visor



Code No: 953531

Cylinder Visor



Code No: 953585

Honeycomb



Code No: 953525

Lampholder	: G 8.5
Reflector	: 9°, 17°, 25°
Gear	: Electronic
Cable	: Potted 5 m 3x0,75 H05 VV-F

METAL HALIDE 35W/70W	Code No
70W	332231

Thermal Management

All fixtures are designed to withstand ambient temperatures of at least 50°C. The LEDs are mounted on metal core pcbs, which are mounted to the aluminium body of the fixture so that the entire fixture acts as a heat sink. Extensive testing is performed in EMFA's laboratory to ensure these values are maintained so that the lifetime of the LED is not compromised.