

EMFA

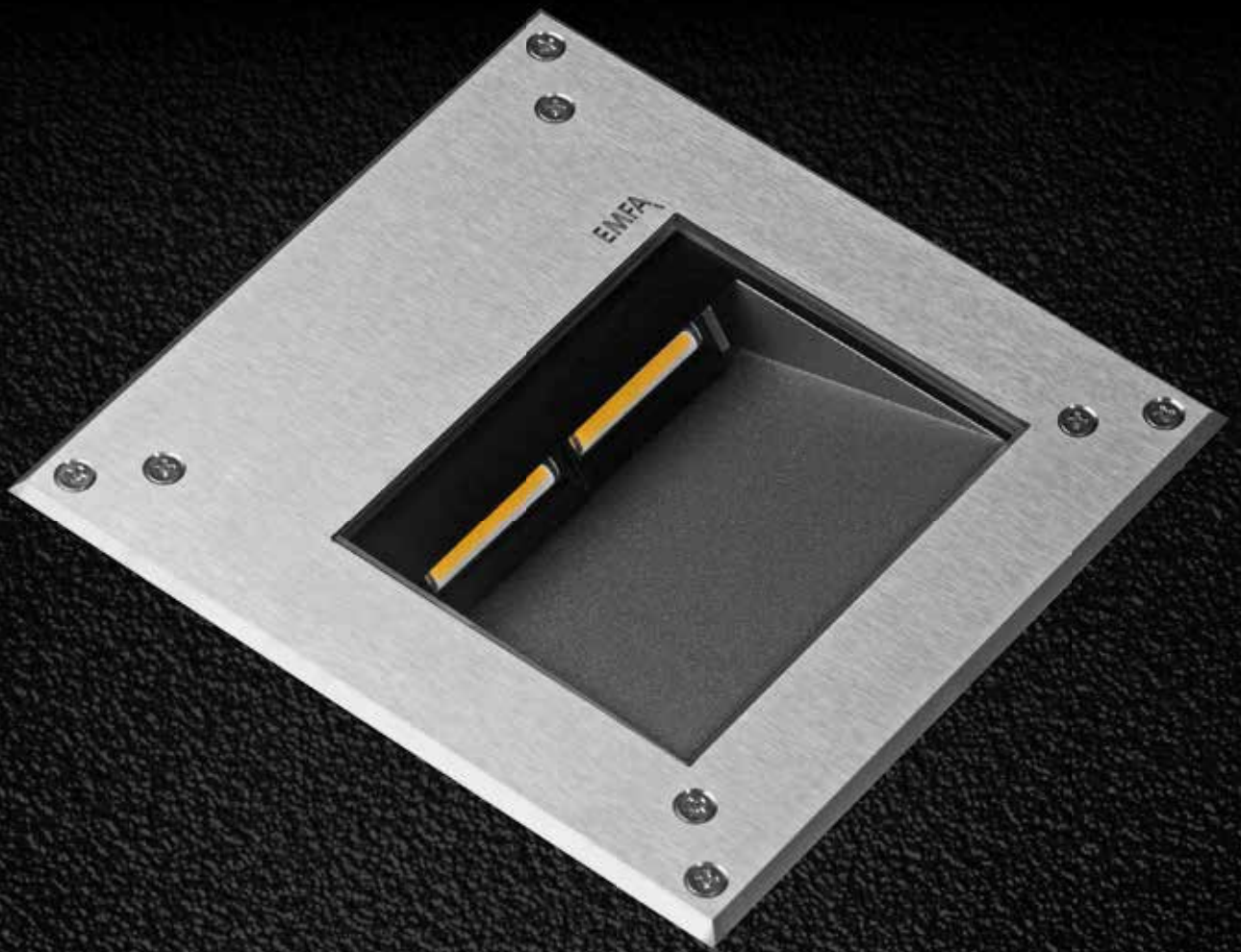

EMFA

MILET ANI RECESSED DRIVE OVER FIXTURES

Load 8 kN | Class I IP67 IK10

EMFA's Ani step mounted series is specially designed to deliver low-glare lighting to facades, columns, monuments, and trees with minimal installation depth and narrow trim. The fixture is made of a combination of 316L stainless steel and die cast aluminium. The tilted design reduces the glare of the LED's. The Linear LEDs with special lenses gives excellent wallwashing effect. An anti-slip glass is available upon request.

- Cover**
316L Stainless steel
- Body**
Die cast aluminium
- Gaskets**
Silicone
- Diffusers**
8 mm Tempered Glass
- Screws**
316L Stainless Steel



“Customization” is EMFA’s standard

EMFA offers many combinations for each fixture, as all fixtures are made in house. A combination of 6 standard paint colors, 8 LED colors, and 2 wattages, and available to make the fixture suitable for the required application. This is done without increasing lead-time and is available for large as well as small quantities.

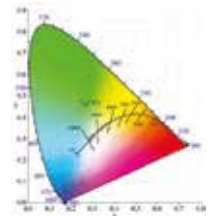

Symmetrical

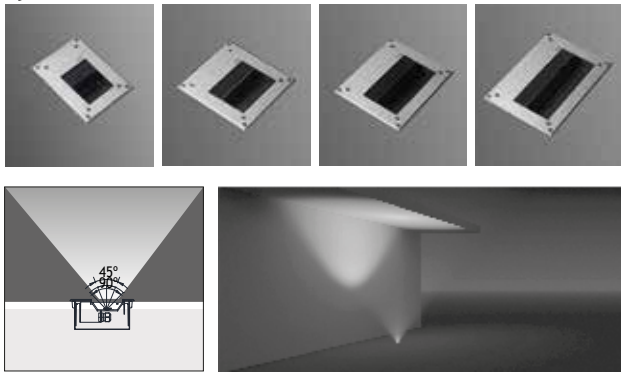

Galvanized Recessing Box

LEDs

Only highest quality LEDs such as Cree or Toplite are used in production allowing for maximum lumen output and maximum lifetime. Most LEDs run on 350mA or 700mA depending on how much light output is required. The white color temperature binning is 200K at most, and always on the same x,y coordinates on the CIE diagram in accordance with Energy Star. This ensures consistent supply of the same color temperature over time. As LEDs are constantly developing and becoming more efficient, lumen output given in this catalogue are current as of March 2020. At 2700K, 3000K, and 4000K LED lumen output per led is 110lm; at 6000K the lumen output per led is 125lm. Total Lighting Output as printed in this catalogue is the actual light output of the entire fixture. The minimum CRI of the LEDs used is 85 with a majority of products over 90.

Asymmetrical

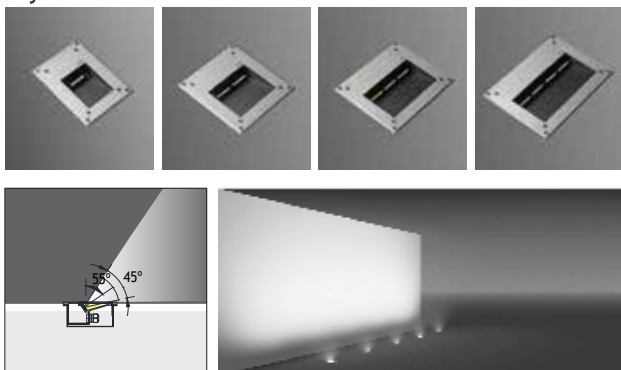

Asym. Glass

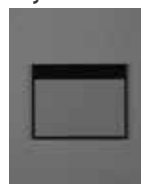

Trenched Glass

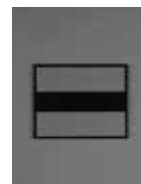

Milky Glass



Clear Glass

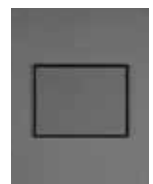

ANI RECESSED DRIVE OVER FIXTURES

Load 8 kN | Class I IP67 IK10

Symmetrical

- Led** : Linear LEDs
- Voltage** : 240 VAC with integrated driver
(12-24 VDC on request)
- Diffuser** : 8mm Tempered Glass
- Beam Angle** : 45° / 60° / 90°
- Mac Adam** : 3
- CRI** : >80
- L.O.R %** : %70

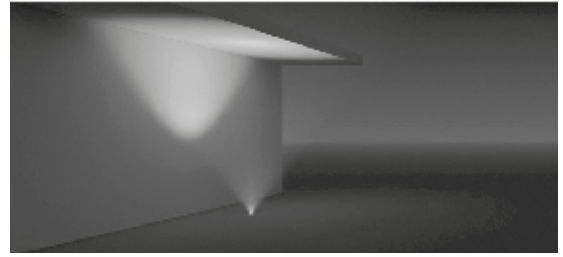
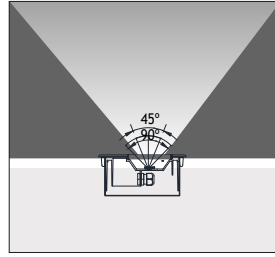

ANI 1			Real Lumen Output	Nominal Lumen Output
Power	Code No	Kelvin		
6W	450001	3000 K	600 lm	850 lm
12W	450011	3000 K	1020 lm	1460 lm
6W	450002	4000 K	690 lm	977 lm
12W	450012	4000 K	1173 lm	1679 lm

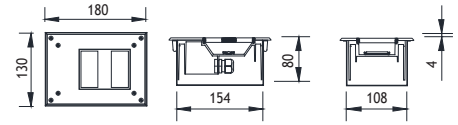

Galvanized Recessing Box

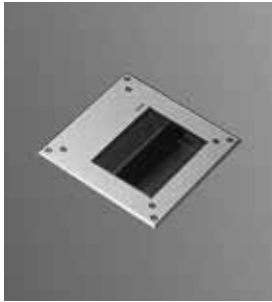

ANI 2			Real Lumen Output	Nominal Lumen Output
Power	Code No	Kelvin		
12W	450101	3000 K	1020 lm	1460 lm
24W	450111	3000 K	1780 lm	2550 lm
12W	450102	4000 K	1173 lm	1679 lm
24W	450112	4000 K	2047 lm	2932 lm

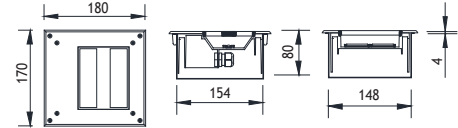

Galvanized Recessing Box

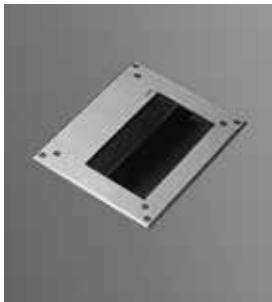

ANI 3			Real Lumen Output	Nominal Lumen Output
Power	Code No	Kelvin		
18W	450201	3000 K	1200 lm	1700 lm
36W	450211	3000 K	2300 lm	3300 lm
18W	450202	4000 K	1380 lm	1955 lm
36W	450212	4000 K	2645 lm	2932 lm

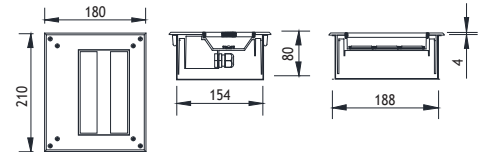

Galvanized Recessing Box

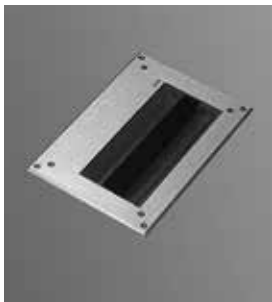

ANI 4			Real Lumen Output	Nominal Lumen Output
Power	Code No	Kelvin		
24W	450301	3000 K	1780 lm	2550 lm
48W	450311	3000 K	3080 lm	4300 lm
24W	450302	4000 K	2047 lm	2932 lm
48W	450312	4000 K	3542 lm	5060 lm

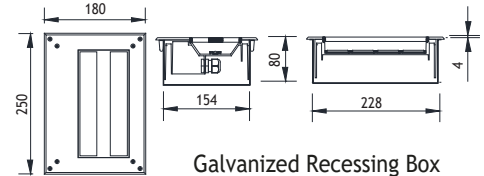

Galvanized Recessing Box

ANI RECESSED DRIVE OVER FIXTURES

Load 8 kN | Class I IP67 IK10

Asymmetrical

- Led** : Linear LEDs
- Voltage** : 240 VAC with integrated driver
(12-24 VDC on request)
- Diffuser** : 8mm Tempered Glass
- Beam Angle** : 45° / 60° / 90°
- Mac Adam** : 3
- CRI** : 80
- L.O.R %** : %70

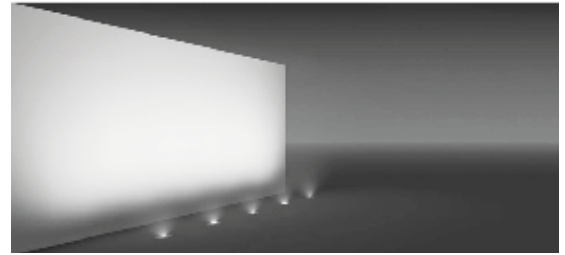
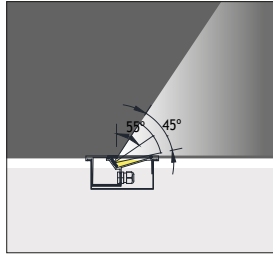

ANI 1			Real Lumen Output	Nominal Lumen Output
Power	Code No	Kelvin		
6W	450501	3000 K	600 lm	850 lm
12W	450511	3000 K	1020 lm	1460 lm
6W	450502	4000 K	690 lm	977 lm
12W	450512	4000 K	1173 lm	1679 lm

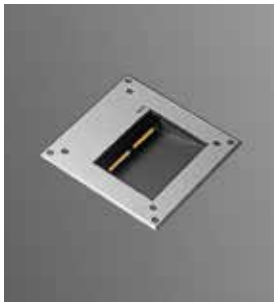
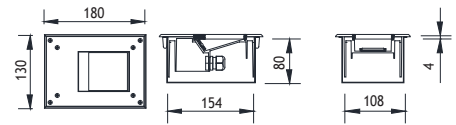

ANI 2			Real Lumen Output	Nominal Lumen Output
Power	Code No	Kelvin		
12W	450601	3000 K	1020 lm	1460 lm
24W	450611	3000 K	1780 lm	2550 lm
12W	450602	4000 K	1173 lm	1679 lm
24W	450612	4000 K	2047 lm	2932 lm

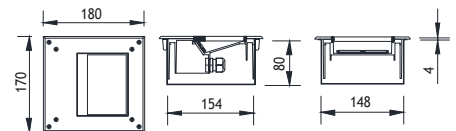

Galvanized Recessing Box

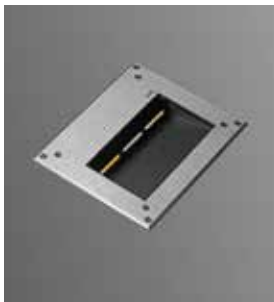

ANI 3			Real Lumen Output	Nominal Lumen Output
Power	Code No	Kelvin		
18W	450701	3000 K	1200 lm	1700 lm
36W	450711	3000 K	2300 lm	3300 lm
18W	450702	4000 K	1380 lm	1955 lm
36W	450712	4000 K	2645 lm	2932 lm

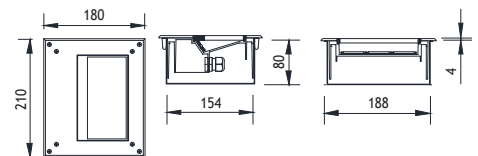

Galvanized Recessing Box



ANI 4			Real Lumen Output	Nominal Lumen Output
Power	Code No	Kelvin		
24W	450801	3000 K	1780 lm	2550 lm
48W	450811	3000 K	3080 lm	4300 lm
24W	450802	4000 K	2047 lm	2932 lm
48W	450812	4000 K	3542 lm	5060 lm

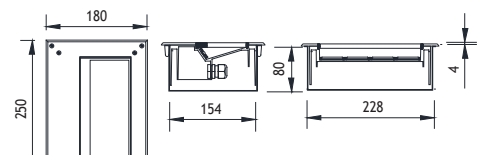

Galvanized Recessing Box

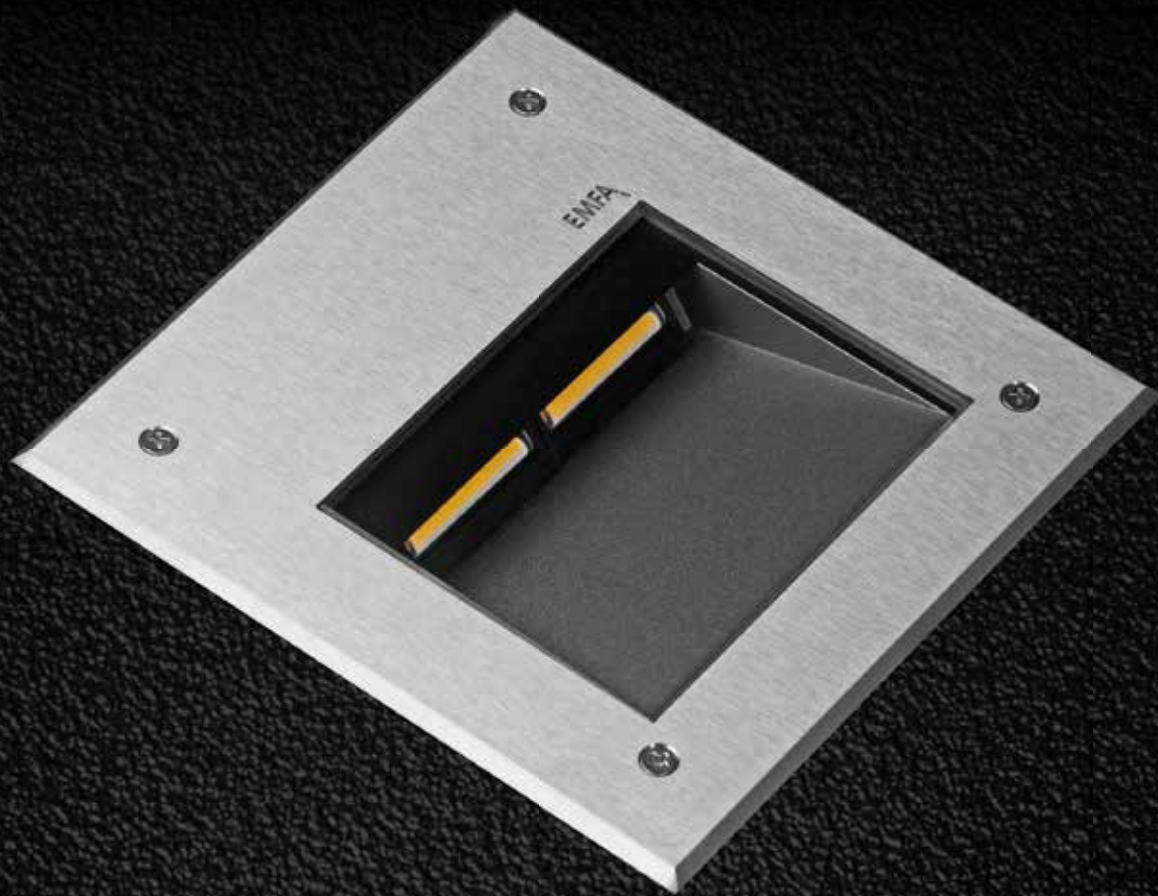

EMFA

MILET ANI RECESSED WALK OVER FIXTURES

Load 2 kN | Class I IP67 IK10

EMFA's Ani step mounted series is specially designed to deliver low-glare lighting to facades, columns, monuments, and trees with minimal installation depth and narrow trim. The fixture is made of a combination of 316L stainless steel and die cast aluminium. The tilted design reduces the glare of the LED's. The Linear LEDs with special lenses gives excellent wallwashing effect. An anti-slip glass is available upon request.

- Cover**
316L Stainless steel
- Body**
Die cast aluminium
- Gaskets**
Silicone
- Diffusers**
8 mm Tempered Glass
- Screws**
316L Stainless Steel



“Customization” is EMFA’s standard

EMFA offers many combinations for each fixture, as all fixtures are made in house. A combination of 6 standard paint colors, 8 LED colors, and 2 wattages, and available to make the fixture suitable for the required application. This is done without increasing lead-time and is available for large as well as small quantities.

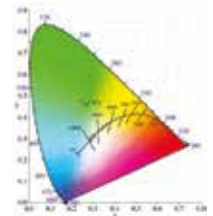

Symmetrical

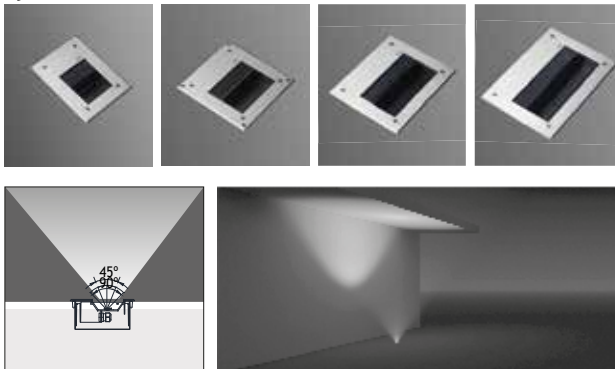

Galvanized Recessing Box

LEDs

Only highest quality LEDs such as Cree or Toplite are used in production allowing for maximum lumen output and maximum lifetime. Most LEDs run on 350mA or 700mA depending on how much light output is required. The white color temperature binning is 200K at most, and always on the same x,y coordinates on the CIE diagram in accordance with Energy Star. This ensures consistent supply of the same color temperature over time. As LEDs are constantly developing and becoming more efficient, lumen output given in this catalogue are current as of March 2020. At 2700K, 3000K, and 4000K LED lumen output per led is 100lm; at 6000K the lumen output per led is 125lm. Total Lighting Output as printed in this catalogue is the actual light output of the entire fixture. The minimum CRI of the LEDs used is 85 with a majority of products over 90.

Asymmetrical

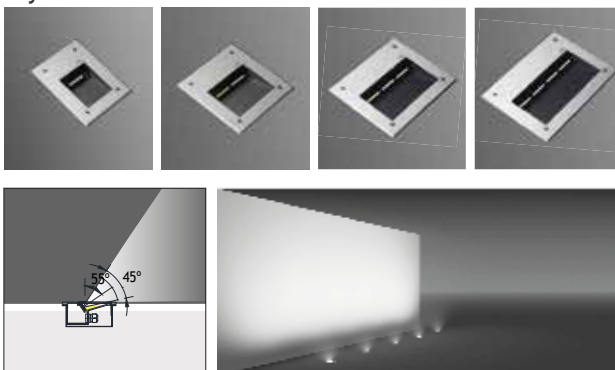

Asym. Glass

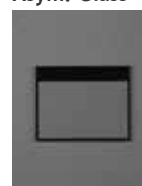

Trenched Glass



Milky Glass



Clear Glass

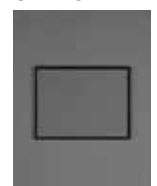

ANI RECESSED WALK OVER FIXTURES

Load 2 kN | Class I IP67 IK10

Symmetrical

- Led** : Linear LEDs
- Voltage** : 240 VAC with integrated driver
(12-24 VDC on request)
- Diffuser** : 8mm Tempered Glass
- Beam Angle** : 45° / 60° / 90°
- Mac Adam** : 3
- CRI** : >80
- L.O.R %** : %70

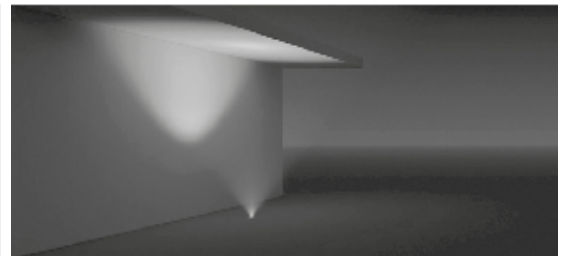
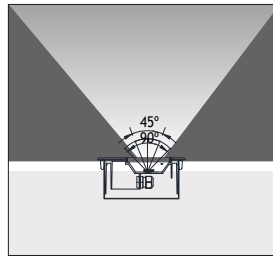

ANI 1

Power	Code No	Kelvin	Real Lumen Output	Nominal Lumen Output
6W	451001	3000 K	600 lm	850 lm
12W	451011	3000 K	1020 lm	1460 lm
6W	451002	4000 K	690 lm	977 lm
12W	451012	4000 K	1173 lm	1679 lm

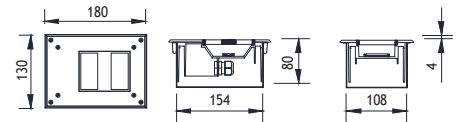

Galvanized Recessing Box

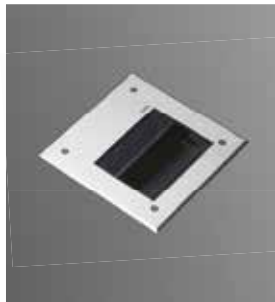

ANI 2

Power	Code No	Kelvin	Real Lumen Output	Nominal Lumen Output
12W	451101	3000 K	1020 lm	1460 lm
24W	451111	3000 K	1780 lm	2550 lm
12W	451102	4000 K	1173 lm	1679 lm
24W	451112	4000 K	2047 lm	2932 lm

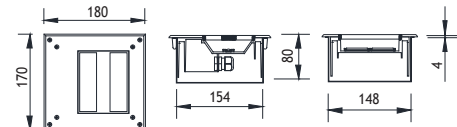

Galvanized Recessing Box

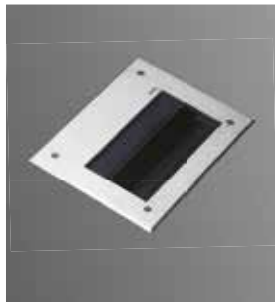

ANI 3

Power	Code No	Kelvin	Real Lumen Output	Nominal Lumen Output
18W	451201	3000 K	1200 lm	1700 lm
36W	451211	3000 K	2300 lm	3300 lm
18W	451202	4000 K	1380 lm	1955 lm
36W	451212	4000 K	2645 lm	2932 lm

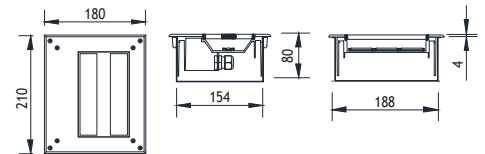

Galvanized Recessing Box

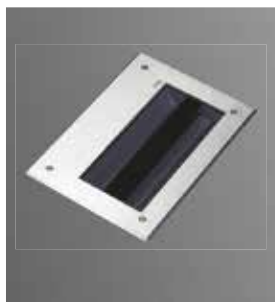

ANI 4

Power	Code No	Kelvin	Real Lumen Output	Nominal Lumen Output
24W	451301	3000 K	1780 lm	2550 lm
48W	451311	3000 K	3080 lm	4300 lm
24W	451302	4000 K	2047 lm	2932 lm
48W	451312	4000 K	3542 lm	5060 lm

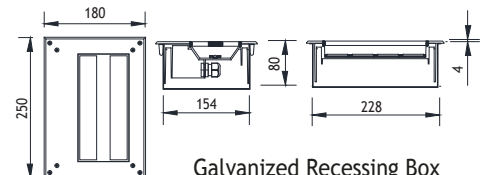

Galvanized Recessing Box

ANI RECESSED WALK OVER FIXTURES

Load 2 kN | Class I IP67 IK10

Asymmetrical

- Led** : Linear LEDs
- Voltage** : 240 VAC with integrated driver
(12-24 VDC on request)
- Diffuser** : 8mm Tempered Glass
- Beam Angle** : 45° / 60° / 90°
- Mac Adam** : 3
- CRI** : 80
- L.O.R %** : %70

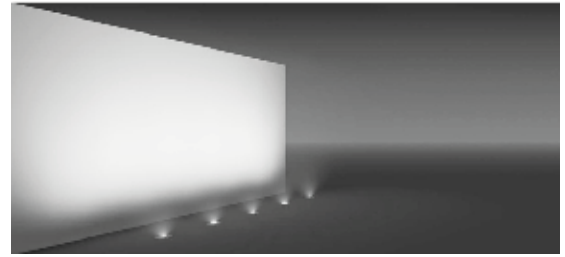
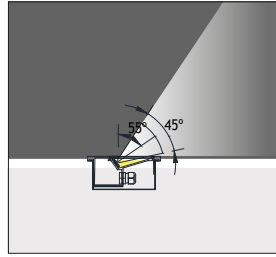

ANI 1			Real Lumen Output	Nominal Lumen Output
Power	Code No	Kelvin		
6W	451501	3000 K	600 lm	850 lm
12W	451511	3000 K	1020 lm	1460 lm
6W	451502	4000 K	690 lm	977 lm
12W	451512	4000 K	1173 lm	1679 lm

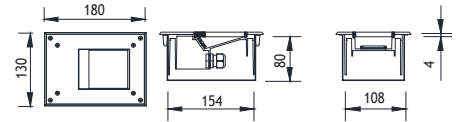

ANI 2			Real Lumen Output	Nominal Lumen Output
Power	Code No	Kelvin		
12W	451601	3000 K	1020 lm	1460 lm
24W	451611	3000 K	1780 lm	2550 lm
12W	451602	4000 K	1173 lm	1679 lm
24W	451612	4000 K	2047 lm	2932 lm

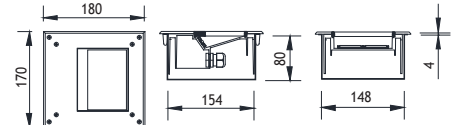

Galvanized Recessing Box

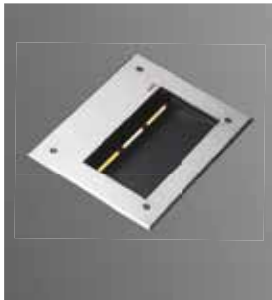

ANI 3			Real Lumen Output	Nominal Lumen Output
Power	Code No	Kelvin		
18W	451701	3000 K	1200 lm	1700 lm
36W	451711	3000 K	2300 lm	3300 lm
18W	451702	4000 K	1380 lm	1955 lm
36W	451712	4000 K	2645 lm	2932 lm

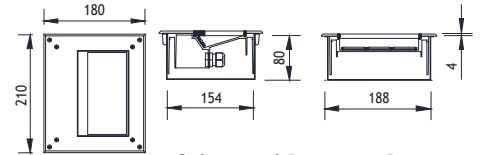

Galvanized Recessing Box



ANI 4			Real Lumen Output	Nominal Lumen Output
Power	Code No	Kelvin		
24W	451801	3000 K	1780 lm	2550 lm
48W	451811	3000 K	3080 lm	4300 lm
24W	451802	4000 K	2047 lm	2932 lm
48W	451812	4000 K	3542 lm	5060 lm

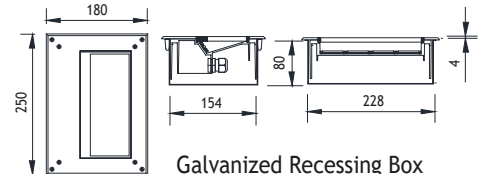

Galvanized Recessing Box



EMFA

MILET ANI WALL RECESSED

Class I IP55 IK08

Available in any of these RAL colors

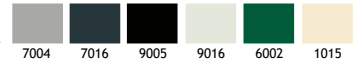

EMFA's Ani wall recessed series is specially designed to deliver low-glare lighting to facades, walkways, pathways and driveways with minimal installation depth and narrow trim. The fixture is made of a combination of 316L stainless steel and die cast aluminium. The tilted design reduces the glare of the LED's. The Linear LEDs with special lenses gives excellent wallwashing effect. An anti-slip glass is available upon request.

Cover

316L Stainless steel or Aluminium

Body

Die cast aluminium

Gaskets

Silicone

Diffusers

4 mm Tempered Glass

Screws

316L Stainless Steel

Glands

PG 11



"Customization" is EMFA's standard

EMFA offers many combinations for each fixture, as all fixtures are made in house. A combination of 6 standard paint colors, 8 LED colors, and 2 wattages, and available to make the fixture suitable for the required application. This is done without increasing lead-time and is available for large as well as small quantities.

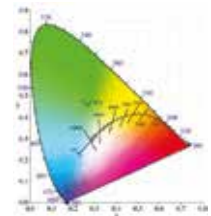

Symmetrical

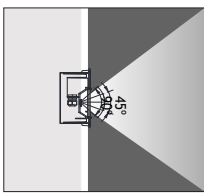
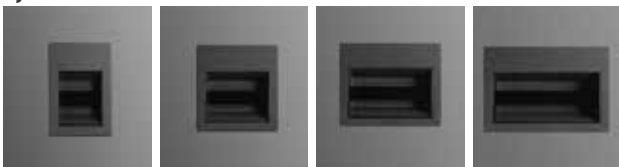

Galvanized Recessing Box



end of the code number "s" add for Screw mounting option for

LEDs

Only highest quality LEDs such as Cree or Toplite are used in production allowing for maximum lumen output and maximum lifetime. Most LEDs run on 350mA or 700mA depending on how much light output is required. The white color temperature binning is 200K at most, and always on the same x,y coordinates on the CIE diagram in accordance with Energy Star. This ensures consistent supply of the same color temperature over time. As LEDs are constantly developing and becoming more efficient, lumen output given in this catalogue are current as of March 2020. At 2700K, 3000K, and 4000K LED lumen output per led is 110lm; at 6000K the lumen output per led is 125lm. Total Lighting Output as printed in this catalogue is the actual light output of the entire fixture. The minimum CRI of the LEDs used is 85 with a majority of products over 90.

Asymmetrical

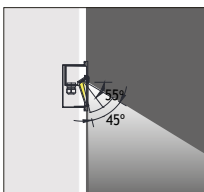
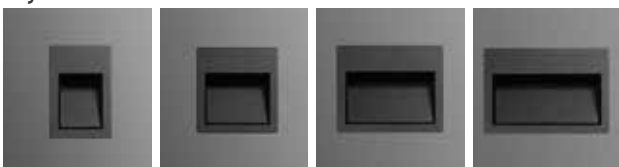

Asym. Glass



Trenched Glass

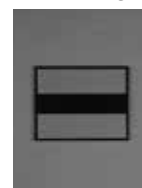

Milky Glass



Clear Glass

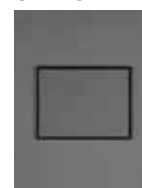

ANI INOX WALL RECESSED

Class I IP55 IK08

Available in any of these RAL colors

7004	7016	9005	9016	6002	1015
------	------	------	------	------	------

Symmetrical

- Led** : Linear LEDs
- Voltage** : 240 VAC with integrated driver
(12-24 VDC on request)
- Diffuser** : 4mm Tempered Glass
- Beam Angle** : 45° / 60° / 90°
- Mac Adam** : 3
- CRI** : >80
- L.O.R %** : %70

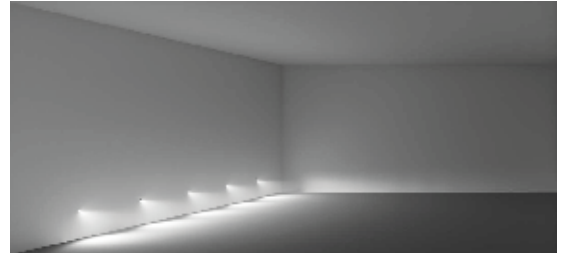
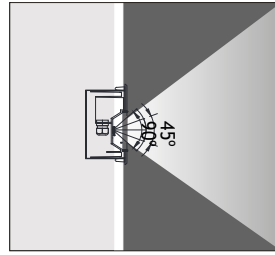

Power	Code No	Kelvin	Real Lumen Output	Nominal Lumen Output
6W	456001	3000 K	600 lm	850 lm
12W	456011	3000 K	1020 lm	1460 lm
6W	456002	4000 K	690 lm	977 lm
12W	456012	4000 K	1173 lm	1679 lm

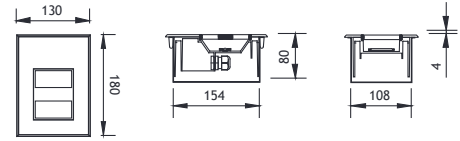

Galvanized Recessing Box



Power	Code No	Kelvin	Real Lumen Output	Nominal Lumen Output
12W	456101	3000 K	1020 lm	1460 lm
24W	456111	3000 K	1780 lm	2550 lm
12W	456102	4000 K	1173 lm	1679 lm
24W	456112	4000 K	2047 lm	2932 lm

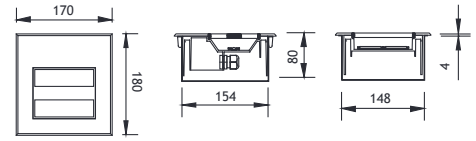

Galvanized Recessing Box



Power	Code No	Kelvin	Real Lumen Output	Nominal Lumen Output
18W	456201	3000 K	1200 lm	1700 lm
36W	456211	3000 K	2300 lm	3300 lm
18W	456202	4000 K	1380 lm	1955 lm
36W	456212	4000 K	2645 lm	2932 lm

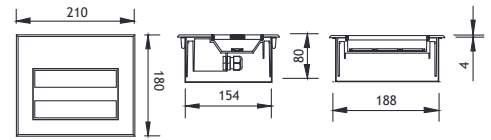

Galvanized Recessing Box



Power	Code No	Kelvin	Real Lumen Output	Nominal Lumen Output
24W	456301	3000 K	1780 lm	2550 lm
48W	456311	3000 K	3080 lm	4300 lm
24W	456302	4000 K	2047 lm	2932 lm
48W	456312	4000 K	3542 lm	5060 lm

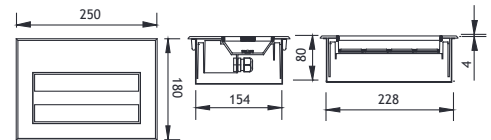

Galvanized Recessing Box

ANI INOX WALL RECESSED Class I IP67 IK08

Available in any
of these RAL colors

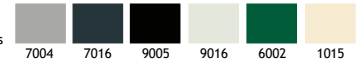

Asymmetrical

- Led** : Linear LEDs
- Voltage** : 240 VAC with integrated driver
(12-24 VDC on request)
- Diffuser** : 4mm Tempered Glass
- Beam Angle** : 45° / 60° / 90°
- Mac Adam** : 3
- CRI** : 80
- L.O.R %** : %64

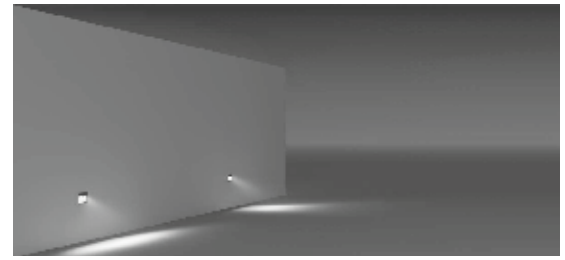
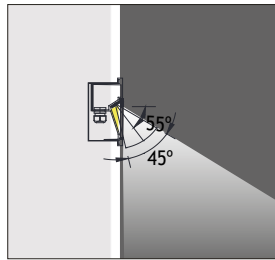

ANI 1			Real Lumen Output	Nominal Lumen Output
Power	Code No	Kelvin		
6W	456501	☀ 3000 K	600 lm	850 lm
12W	456511	☀ 3000 K	1020 lm	1460 lm
6W	456502	☾ 4000 K	690 lm	977 lm
12W	456512	☾ 4000 K	1173 lm	1679 lm

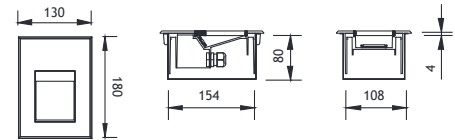

ANI 2			Real Lumen Output	Nominal Lumen Output
Power	Code No	Kelvin		
12W	456601	☀ 3000 K	1020 lm	1460 lm
24W	456611	☀ 3000 K	1780 lm	2550 lm
12W	456602	☾ 4000 K	1173 lm	1679 lm
24W	456612	☾ 4000 K	2047 lm	2932 lm

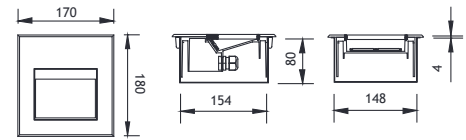

Galvanized Recessing Box



ANI 3			Real Lumen Output	Nominal Lumen Output
Power	Code No	Kelvin		
18W	456701	☀ 3000 K	1200 lm	1700 lm
36W	456711	☀ 3000 K	2300 lm	3300 lm
18W	456702	☾ 4000 K	1380 lm	1955 lm
36W	456712	☾ 4000 K	2645 lm	2932 lm

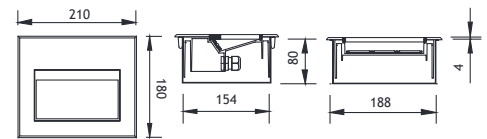

Galvanized Recessing Box



ANI 4			Real Lumen Output	Nominal Lumen Output
Power	Code No	Kelvin		
24W	456801	☀ 3000 K	1780 lm	2550 lm
48W	456811	☀ 3000 K	3080 lm	4300 lm
24W	456802	☾ 4000 K	2047 lm	2932 lm
48W	456812	☾ 4000 K	3542 lm	5060 lm

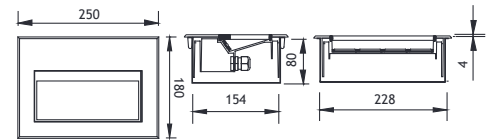

Galvanized Recessing Box

ANI ALUM WALL RECESSED

Class I IP55 IK08

Available in any of these RAL colors

7004	7016	9005	9016	6002	1015
------	------	------	------	------	------

Symmetrical

- Led** : Linear LEDs
- Voltage** : 240 VAC with integrated driver
(12-24 VDC on request)
- Diffuser** : 4mm Tempered Glass
- Beam Angle** : 45° / 60° / 90°
- Mac Adam** : 3
- CRI** : >80
- L.O.R %** : %70

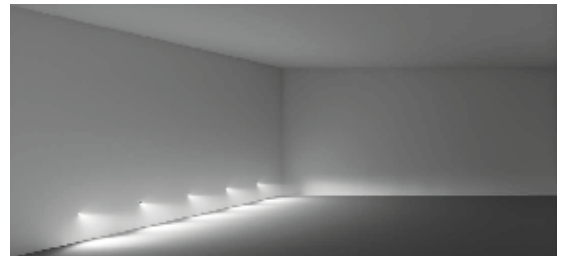
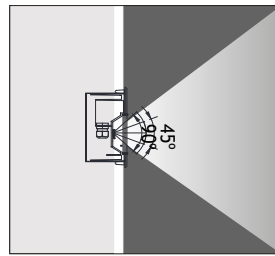

Power	Code No	Kelvin	Real Lumen Output	Nominal Lumen Output
6W	455001	3000 K	600 lm	850 lm
12W	455011	3000 K	1020 lm	1460 lm
6W	455002	4000 K	690 lm	977 lm
12W	455012	4000 K	1173 lm	1679 lm

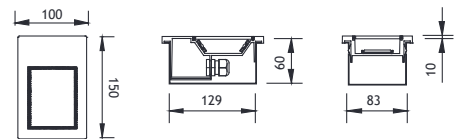

Galvanized Recessing Box



Power	Code No	Kelvin	Real Lumen Output	Nominal Lumen Output
12W	455101	3000 K	1020 lm	1460 lm
24W	455111	3000 K	1780 lm	2550 lm
12W	455102	4000 K	1173 lm	1679 lm
24W	455112	4000 K	2047 lm	2932 lm

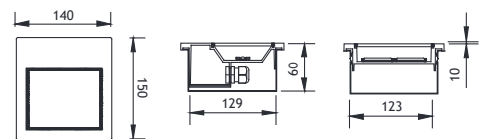

Galvanized Recessing Box



Power	Code No	Kelvin	Real Lumen Output	Nominal Lumen Output
18W	455201	3000 K	1200 lm	1700 lm
36W	455211	3000 K	2300 lm	3300 lm
18W	455202	4000 K	1380 lm	1955 lm
36W	455212	4000 K	2645 lm	2932 lm

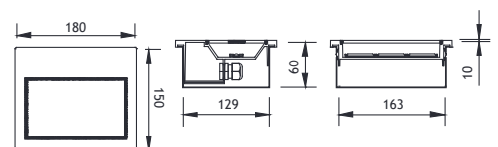

Galvanized Recessing Box



Power	Code No	Kelvin	Real Lumen Output	Nominal Lumen Output
24W	455301	3000 K	1780 lm	2550 lm
48W	455311	3000 K	3080 lm	4300 lm
24W	455302	4000 K	2047 lm	2932 lm
48W	455312	4000 K	3542 lm	5060 lm

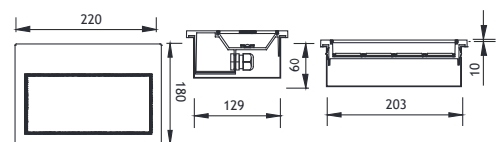

Galvanized Recessing Box

ANI ALUM WALL RECESSED

Class I IP55 IK08

Available in any of these RAL colors

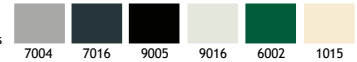

Asymmetrical

- Led** : Linear LEDs
- Voltage** : 240 VAC with integrated driver
(12-24 VDC on request)
- Diffuser** : 4mm Tempered Glass
- Beam Angle** : 45° / 60° / 90°
- Mac Adam** : 3
- CRI** : 80
- L.O.R %** : %64

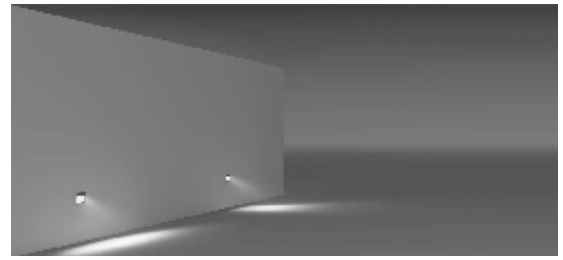
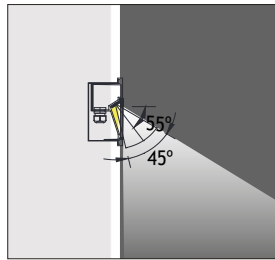

ANI 1			Real Lumen Output	Nominal Lumen Output
Power	Code No	Kelvin		
6W	455501	3000 K	600 lm	850 lm
12W	455511	3000 K	1020 lm	1460 lm
6W	455502	4000 K	690 lm	977 lm
12W	455512	4000 K	1173 lm	1679 lm

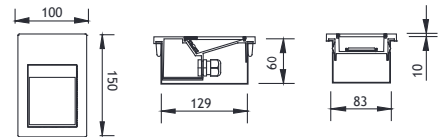

ANI 2			Real Lumen Output	Nominal Lumen Output
Power	Code No	Kelvin		
12W	455601	3000 K	1020 lm	1460 lm
24W	455611	3000 K	1780 lm	2550 lm
12W	455602	4000 K	1173 lm	1679 lm
24W	455612	4000 K	2047 lm	2932 lm

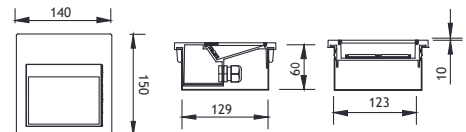

Galvanized Recessing Box



ANI 3			Real Lumen Output	Nominal Lumen Output
Power	Code No	Kelvin		
18W	455701	3000 K	1200 lm	1700 lm
36W	455711	3000 K	2300 lm	3300 lm
18W	455702	4000 K	1380 lm	1955 lm
36W	455712	4000 K	2645 lm	2932 lm

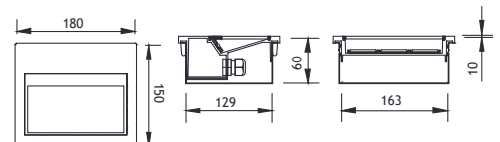

Galvanized Recessing Box



ANI 4			Real Lumen Output	Nominal Lumen Output
Power	Code No	Kelvin		
24W	455801	3000 K	1780 lm	2550 lm
48W	455811	3000 K	3080 lm	4300 lm
24W	455802	4000 K	2047 lm	2932 lm
48W	455812	4000 K	3542 lm	5060 lm

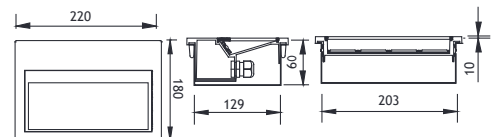

Galvanized Recessing Box

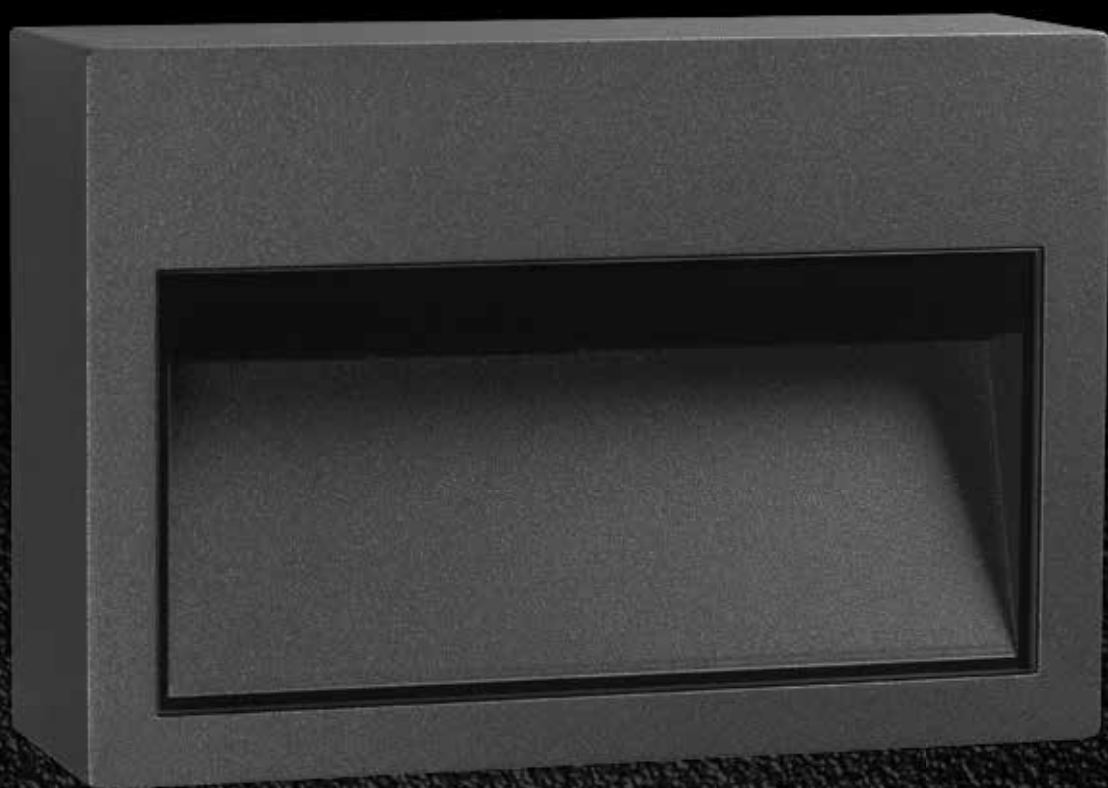

EMFA

MILET ANI WALL SURFACE RECESSED

Class I IP55 IK08

Available in any of these RAL colors

7004	7016	9005	9016	6002	1015
------	------	------	------	------	------

EMFA's Ani surface mounted series is specially designed to deliver low-glare lighting to facades, walkways, pathways and driveways with minimal installation depth and narrow trim. The fixture is made of a combination of 316L stainless steel and die cast aluminium. The tilted design reduces the glare of the LED's. The Linear LEDs with special lenses gives excellent wallwashing effect. An anti-slip glass is available upon request.

Body

Die cast aluminium

Gaskets

Silicone

Diffusers

4 mm Tempered Glass

Screws

316L Stainless Steel

Glands

PG 11



“Customization” is EMFA’s standard

EMFA offers many combinations for each fixture, as all fixtures are made in house. A combination of 6 standard paint colors, 8 LED colors, and 2 wattages, and available to make the fixture suitable for the required application. This is done without increasing lead-time and is available for large as well as small quantities.

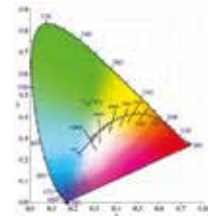

Symmetrical

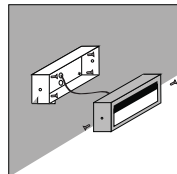

Galvanized Recessing Box



end of the code number "s" add for Screw mounting option for

LEDs

Only highest quality LEDs such as Cree or Toplite are used in production allowing for maximum lumen output and maximum lifetime. Most LEDs run on 350mA or 700mA depending on how much light output is required. The white color temperature binning is 200K at most, and always on the same x,y coordinates on the CIE diagram in accordance with Energy Star. This ensures consistent supply of the same color temperature over time. As LEDs are constantly developing and becoming more efficient, lumen output given in this catalogue are current as of March 2020. At 2700K, 3000K, and 4000K LED lumen output per led is 110lm; at 6000K the lumen output per led is 125lm. Total Lighting Output as printed in this catalogue is the actual light output of the entire fixture. The minimum CRI of the LEDs used is 85 with a majority of products over 90.

Asymmetrical

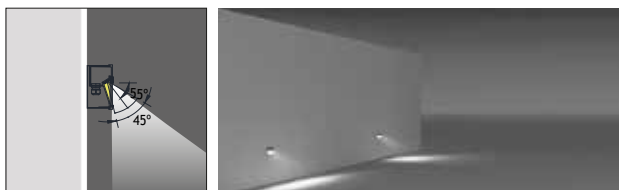
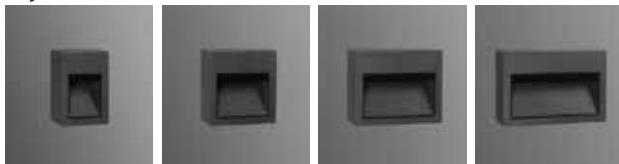

Asym. Glass



Trenched Glass

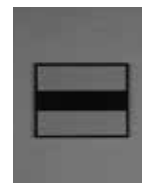

Milky Glass



Clear Glass

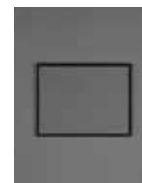

ANI WALL SURFACE MOUNTED Class I IP55 IK08

Available in any of these RAL colors

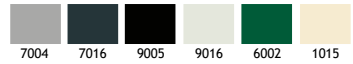

Symmetrical

- Led** : Linear LEDs
- Voltage** : 240 VAC with integrated driver
(12-24 VDC on request)
- Diffuser** : 4mm Tempered Glass
- Beam Angle** : 45° / 60° / 90°
- Mac Adam** : 3
- CRI** : >80
- L.O.R %** : %70

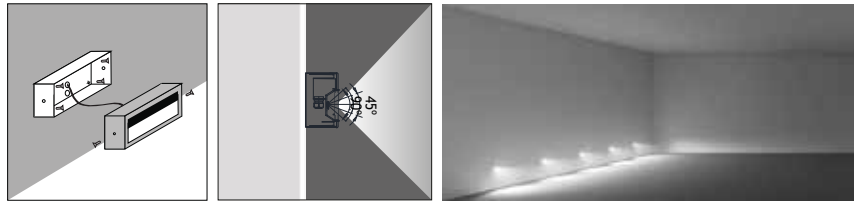

Galvanized
Mounting Box



Power	Code No	Kelvin	Real Lumen Output	Nominal Lumen Output
6W	457001	3000 K	600 lm	850 lm
12W	457011	3000 K	1020 lm	1460 lm
6W	457002	4000 K	690 lm	977 lm
12W	457012	4000 K	1173 lm	1679 lm

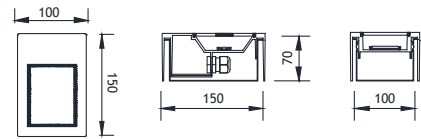

Galvanized Mounting Box



Power	Code No	Kelvin	Real Lumen Output	Nominal Lumen Output
12W	457101	3000 K	1020 lm	1460 lm
24W	457111	3000 K	1780 lm	2550 lm
12W	457102	4000 K	1173 lm	1679 lm
24W	457112	4000 K	2047 lm	2932 lm

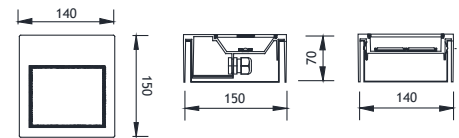

Galvanized Mounting Box



Power	Code No	Kelvin	Real Lumen Output	Nominal Lumen Output
18W	457201	3000 K	1200 lm	1700 lm
36W	457211	3000 K	2300 lm	3300 lm
18W	457202	4000 K	1380 lm	1955 lm
36W	457212	4000 K	2645 lm	2932 lm

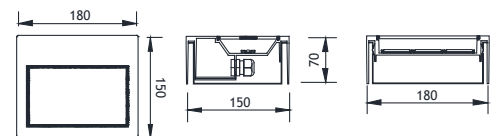

Galvanized Mounting Box

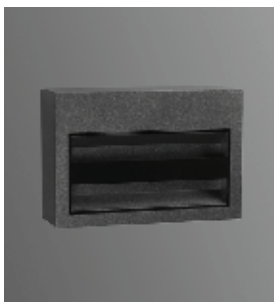

Power	Code No	Kelvin	Real Lumen Output	Nominal Lumen Output
24W	457301	3000 K	1780 lm	2550 lm
48W	457311	3000 K	3080 lm	4300 lm
24W	457302	4000 K	2047 lm	2932 lm
48W	457312	4000 K	3542 lm	5060 lm

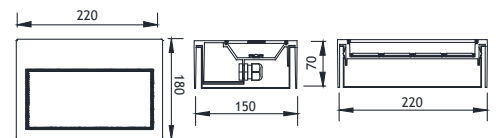

Galvanized Mounting Box

ANI WALL SURFACE MOUNTED

Class I IP55 IK08

Available in any of these RAL colors

7004	7016	9005	9016	6002	1015
------	------	------	------	------	------

Asymmetrical

- Led** : Linear LEDs
- Voltage** : 240 VAC with integrated driver
(12-24 VDC on request)
- Diffuser** : 4mm Tempered Glass
- Beam Angle** : 45° / 60° / 90°
- Mac Adam** : 3
- CRI** : 80
- L.O.R %** : %70

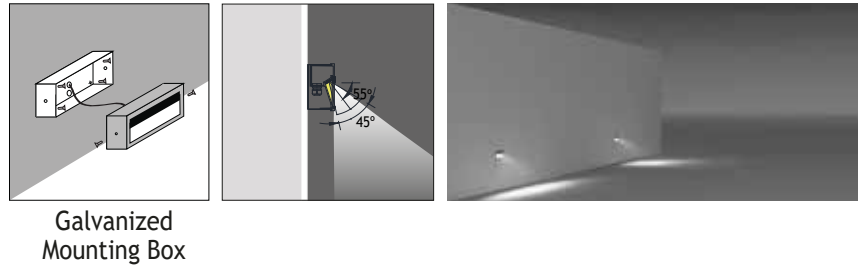

Power	Code No	Kelvin	Real Lumen Output	Nominal Lumen Output
6W	457501	3000 K	600 lm	850 lm
12W	457511	3000 K	1020 lm	1460 lm
6W	457502	4000 K	690 lm	977 lm
12W	457512	4000 K	1173 lm	1679 lm

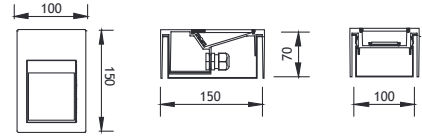

Galvanized Mounting Box



Power	Code No	Kelvin	Real Lumen Output	Nominal Lumen Output
12W	457601	3000 K	1020 lm	1460 lm
24W	457611	3000 K	1780 lm	2550 lm
12W	457602	4000 K	1173 lm	1679 lm
24W	457612	4000 K	2047 lm	2932 lm

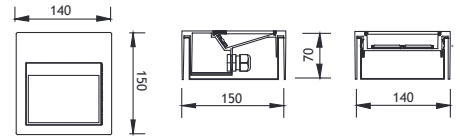

Galvanized Mounting Box

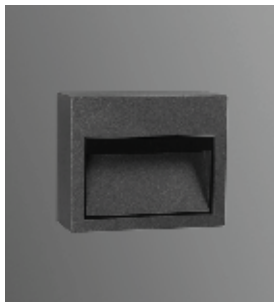

Power	Code No	Kelvin	Real Lumen Output	Nominal Lumen Output
18W	457701	3000 K	1200 lm	1700 lm
36W	457711	3000 K	2300 lm	3300 lm
18W	457702	4000 K	1380 lm	1955 lm
36W	457712	4000 K	2645 lm	2932 lm

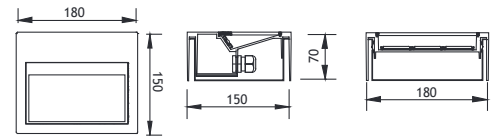

Galvanized Mounting Box

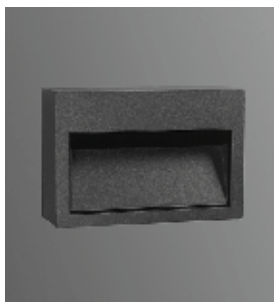

Power	Code No	Kelvin	Real Lumen Output	Nominal Lumen Output
24W	457801	3000 K	1780 lm	2550 lm
48W	457811	3000 K	3080 lm	4300 lm
24W	457802	4000 K	2047 lm	2932 lm
48W	457812	4000 K	3542 lm	5060 lm

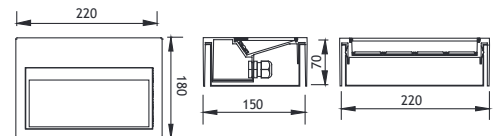

Galvanized Mounting Box



EMFA

ANI WALLWASHER LED SPOTS

Class I IP55 IK08

Available in any of these RAL colors

7004	7016	9005	9016	6002	1015
------	------	------	------	------	------

Symmetrical

- Led** : Linear LEDs
- Voltage** : 240 VAC with integrated driver
(12-24 VDC on request)
- Diffuser** : 4mm Tempered Glass
- Beam Angle** : 45° / 60° / 90°
- Mac Adam** : 3
- CRI** : >80
- L.O.R %** : %70

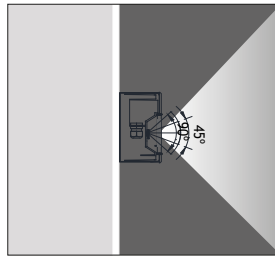

ANI 1			Real Lumen Output	Nominal Lumen Output
Power	Code No	Kelvin		
6W	454001	3000 K	600 lm	850 lm
12W	454011	3000 K	1020 lm	1460 lm
6W	454002	4000 K	690 lm	977 lm
12W	454012	4000 K	1173 lm	1679 lm

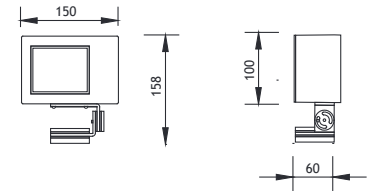

ANI 2			Real Lumen Output	Nominal Lumen Output
Power	Code No	Kelvin		
12W	454101	3000 K	1020 lm	1460 lm
24W	454111	3000 K	1780 lm	2550 lm
12W	454102	4000 K	1173 lm	1679 lm
24W	454112	4000 K	2047 lm	2932 lm

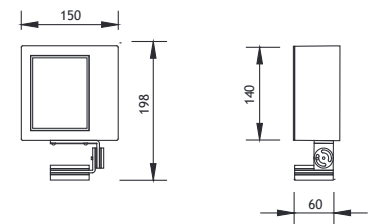

ANI 3			Real Lumen Output	Nominal Lumen Output
Power	Code No	Kelvin		
18W	454201	3000 K	1200 lm	1700 lm
36W	454211	3000 K	2300 lm	3300 lm
18W	454202	4000 K	1380 lm	1955 lm
36W	454212	4000 K	2645 lm	2932 lm

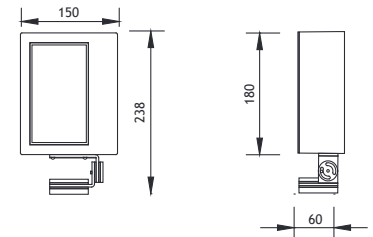

ANI 4			Real Lumen Output	Nominal Lumen Output
Power	Code No	Kelvin		
24W	454301	3000 K	1780 lm	2550 lm
48W	454311	3000 K	3080 lm	4300 lm
24W	454302	4000 K	2047 lm	2932 lm
48W	454312	4000 K	3542 lm	5060 lm

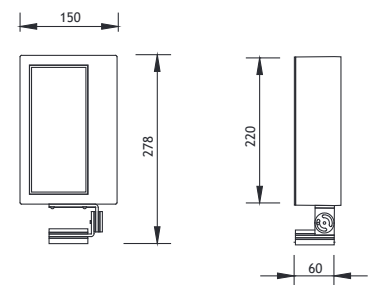

MILET ANI WALLWASHER LED SPOTS

Class I IP55 IK08

Available in any of these RAL colors

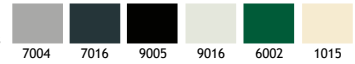

EMFA's Ani wallwasher series is specially designed to deliver low-glare lighting to facades, walkways, pathways and driveways with minimal installation depth and narrow trim. The fixture is made of a combination of 316L stainless steel and die cast aluminium. The tilted design reduces the glare of the LED's The Linear LEDs with special lenses gives excellent wallwashing effect. An anti-slip glass is available upon request.

Body

Die cast aluminium

Gaskets

Silicone

Diffusers

4 mm Tempered Glass

Screws

316L Stainless Steel

Glands

PG 11



“Customization” is EMFA’s standard

EMFA offers many combinations for each fixture, as all fixtures are made in house. A combination of 6 standard paint colors, 8 LED colors, and 2 wattages, and available to make the fixture suitable for the required application. This is done without increasing lead-time and is available for large as well as small quantities.

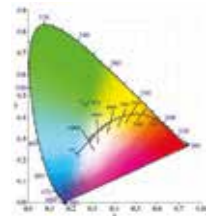

Symmetrical

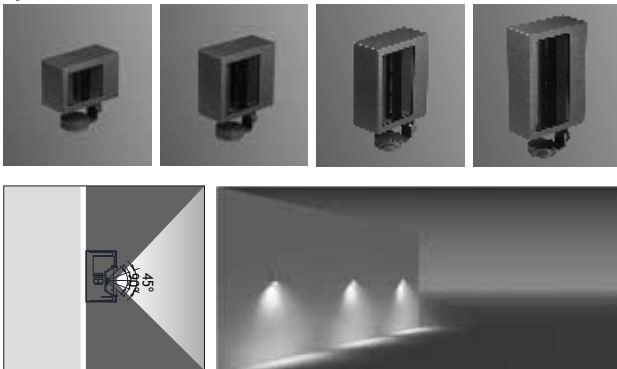

Asymmetrical

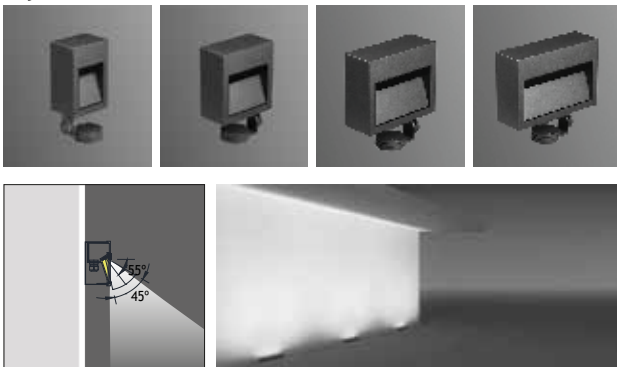

LEDs

Only highest quality LEDs such as Cree or Toplite are used in production allowing for maximum lumen output and maximum lifetime. Most LEDs run on 350mA or 700mA depending on how much light output is required. The white color temperature binning is 200K at most, and always on the same x,y coordinates on the CIE diagram in accordance with Energy Star. This ensures consistent supply of the same color temperature over time. As LEDs are constantly developing and becoming more efficient, lumen output given in this catalogue are current as of March 2020. At 2700K, 3000K, and 4000K LED lumen output per led is 110lm; at 6000K the lumen output per led is 125lm. Total Lighting Output as printed in this catalogue is the actual light output of the entire fixture. The minimum CRI of the LEDs used is 85 with a majority of products over 90.

Asym. Glass

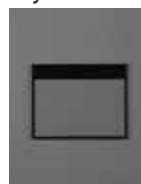

Trenched Glass

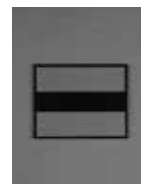

Milky Glass



Clear Glass

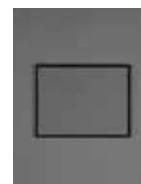

ANI WALLWASHER LED SPOTS

Class I IP55 IK08

Available in any of these RAL colors

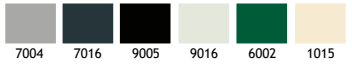

Asymmetrical

- Led** : Linear LEDs
- Voltage** : 240 VAC with integrated driver
(12-24 VDC on request)
- Diffuser** : 4mm Tempered Glass
- Beam Angle** : 45° / 60° / 90°
- Mac Adam** : 3
- CRI** : 80
- L.O.R %** : %64

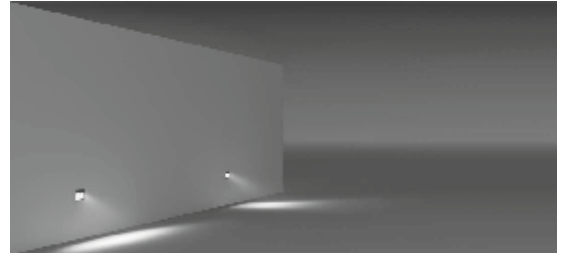
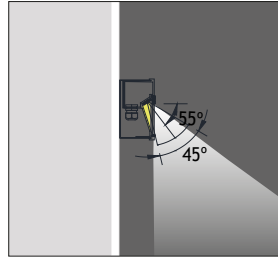

ANI 1			Real Lumen Output	Nominal Lumen Output
Power	Code No	Kelvin		
6W	454501	☀ 3000 K	600 lm	850 lm
12W	454511	☀ 3000 K	1020 lm	1460 lm
6W	454502	☾ 4000 K	690 lm	977 lm
12W	454512	☾ 4000 K	1173 lm	1679 lm

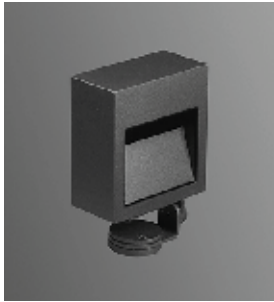
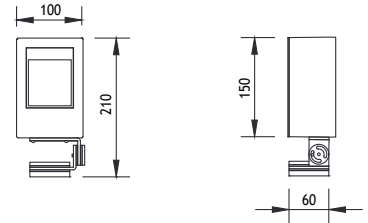

ANI 2			Real Lumen Output	Nominal Lumen Output
Power	Code No	Kelvin		
12W	454601	☀ 3000 K	1020 lm	1460 lm
24W	454611	☀ 3000 K	1780 lm	2550 lm
12W	454602	☾ 4000 K	1173 lm	1679 lm
24W	454612	☾ 4000 K	2047 lm	2932 lm

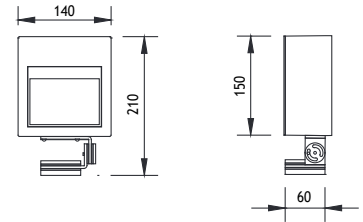

ANI 3			Real Lumen Output	Nominal Lumen Output
Power	Code No	Kelvin		
18W	454701	☀ 3000 K	1200 lm	1700 lm
36W	454711	☀ 3000 K	2300 lm	3300 lm
18W	454702	☾ 4000 K	1380 lm	1955 lm
36W	454712	☾ 4000 K	2645 lm	2932 lm

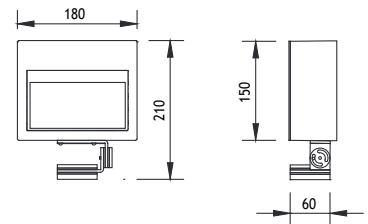

ANI 4			Real Lumen Output	Nominal Lumen Output
Power	Code No	Kelvin		
24W	454801	☀ 3000 K	1780 lm	2550 lm
48W	454811	☀ 3000 K	3080 lm	4300 lm
24W	454802	☾ 4000 K	2047 lm	2932 lm
48W	454812	☾ 4000 K	3542 lm	5060 lm

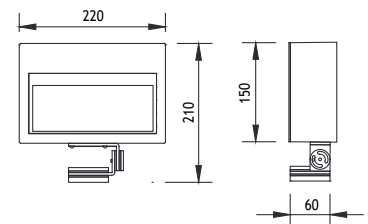



EMFA

ANI ALUM LED BOLLARD

Class I IP55 IK08

Available in any of these RAL colors

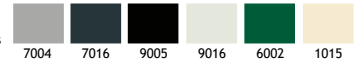

EMFA's Ani Bollard combines a die-cast aluminium head housing an LED unit with an extrusion aluminium pipe. The bollard is designed to light pathways, landscapes and open spaces. The Ani bollard gives light only in the downward direction. This avoids any kind of glare and light pollution. The head and pipe are connected by a hidden screw within the pipe. The head contains LEDs that can be powered up to 12W. An optional galvanized steel anchorage kit is available for mounting into concrete. An alternative option is sleeve anchors for mounting onto existing concrete or a picket to mount into the earth.

- Profile**
- Aluminium
- Body**
- Die cast aluminium
- Gaskets**
- Silicone
- Diffusers**
- 4 mm Tempered Glass
- Screws**
- 316L Stainless steel
- Glands**
- PG 11

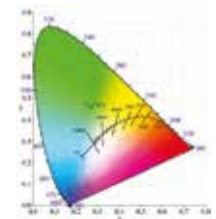

“Customization” is EMFA’s standard

EMFA offers many combinations for each fixture, as all fixtures are made in house. A combination of 6 standard paint colors, 8 LED colors, and 2 wattages, are available to make the fixture suitable for the required application. This is done without increasing lead-time and is available for large as well as small quantities.

LEDs

Only highest quality LEDs such as Cree or Toplite are used in production allowing for maximum lumen output and maximum lifetime. Most LEDs run on 350mA or 700mA depending on how much light output is required. The white color temperature binning is 200K at most, and always on the same x,y coordinates on the CIE diagram in accordance with Energy Star. This ensures consistent supply of the same color temperature over time. As LEDs are constantly developing and becoming more efficient, lumen output given in this catalogue are current as of March 2020. At 2700K, 3000K, and 4000K LED lumen output per led is 110lm; at 6000K the lumen output per led is 125lm. Total Lighting Output as printed in this catalogue is the actual light output of the entire fixture. The minimum CRI of the LEDs used is 85 with a majority of products over 90.

Symmetrical

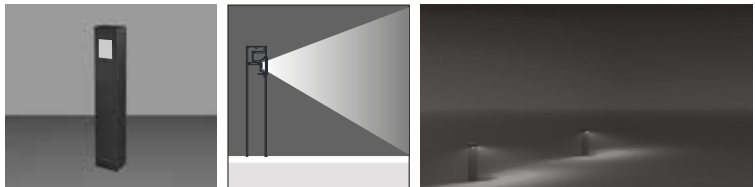

Asymmetrical

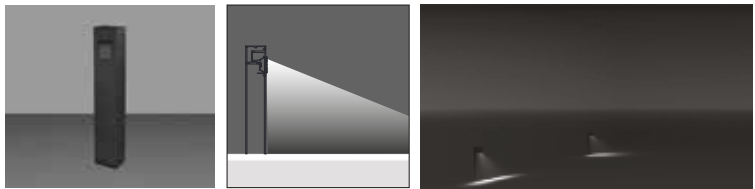

- Asym. Glass
- Trenched Glass
- Milky Glass
- Clear Glass

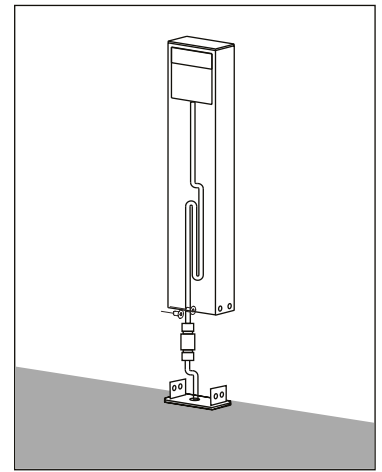

ANI 1 ALUM LED BOLLARD

Class I IP55 IK08

Available in any of these RAL colors

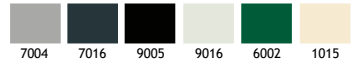

Symmetrical

- Led** : Linear LEDs
- Voltage** : 240 VAC with integrated driver
(12-24 VDC on request)
- Diffuser** : 4mm Tempered Glass
- Beam Angle** : 45° / 60° / 90°
- Mac Adam** : 3
- CRI** : >80
- L.O.R %** : %70

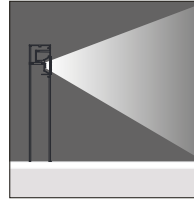

450mm

Power	Code No	Kelvin	Real Lumen Output	Nominal Lumen Output
6W	452001	3000 K	600 lm	850 lm
12W	452011	3000 K	1020 lm	1460 lm
6W	452002	4000 K	690 lm	977 lm
12W	452012	4000 K	1173 lm	1679 lm

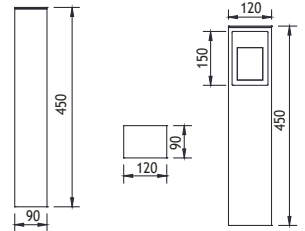

700mm

Power	Code No	Kelvin	Real Lumen Output	Nominal Lumen Output
6W	452101	3000 K	600 lm	850 lm
12W	452111	3000 K	1020 lm	1460 lm
6W	452102	4000 K	690 lm	977 lm
12W	452112	4000 K	1173 lm	1679 lm

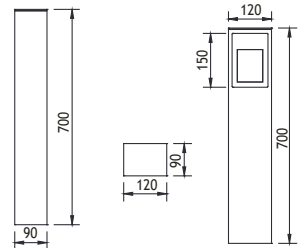

1100mm

Power	Code No	Kelvin	Real Lumen Output	Nominal Lumen Output
6W	452201	3000 K	600 lm	850 lm
12W	452211	3000 K	1020 lm	1460 lm
6W	452202	4000 K	690 lm	977 lm
12W	452212	4000 K	1173 lm	1679 lm

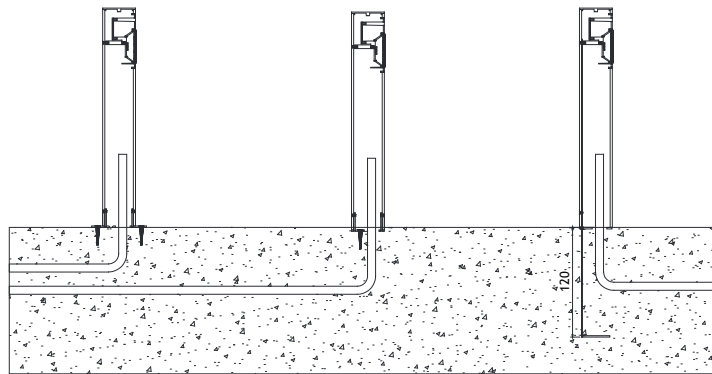
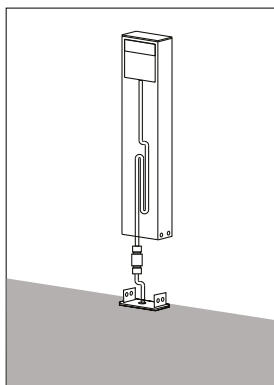
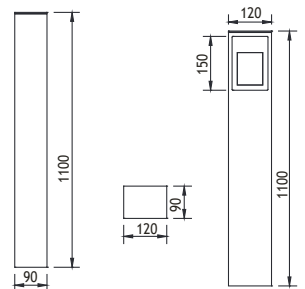

Concrete Mounting Step

Concrete Mounting Flush

Galvanized Steel Anchor

ANI 1 ALUM LED BOLLARD

Class I IP55 IK08

Available in any of these RAL colors

7004	7016	9005	9016	6002	1015
------	------	------	------	------	------

Asymmetrical

- Led** : Linear LEDs
- Voltage** : 240 VAC with integrated driver
(12-24 VDC on request)
- Diffuser** : 4mm Tempered Glass
- Beam Angle** : 45° / 60° / 90°
- Mac Adam** : 3
- CRI** : >80
- L.O.R %** : %70

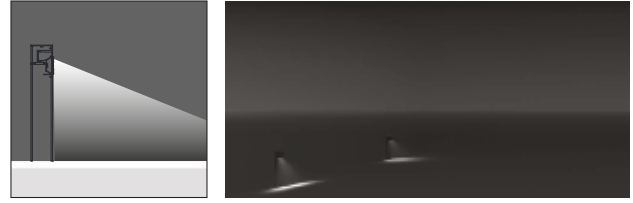

Power	Code No	Kelvin	Real Lumen Output	Nominal Lumen Output
6W	452501	3000 K	600 lm	850 lm
12W	452511	3000 K	1020 lm	1460 lm
6W	452502	4000 K	690 lm	977 lm
12W	452512	4000 K	1173 lm	1679 lm

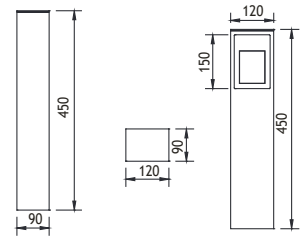

Power	Code No	Kelvin	Real Lumen Output	Nominal Lumen Output
6W	452601	3000 K	600 lm	850 lm
12W	452611	3000 K	1020 lm	1460 lm
6W	452602	4000 K	690 lm	977 lm
12W	452612	4000 K	1173 lm	1679 lm

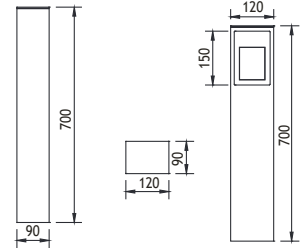

Power	Code No	Kelvin	Real Lumen Output	Nominal Lumen Output
6W	452701	3000 K	600 lm	850 lm
12W	452711	3000 K	1020 lm	1460 lm
6W	452702	4000 K	690 lm	977 lm
12W	452712	4000 K	1173 lm	1679 lm

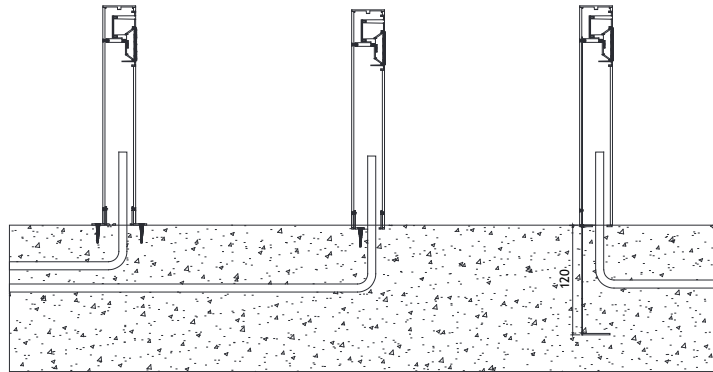
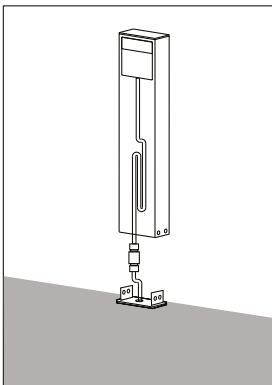
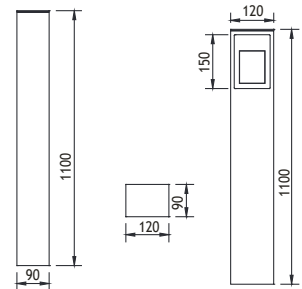

Concrete Mounting Step

Concrete Mounting Flush

Galvanized Steel Anchor

ANI 4 ALUM LED BOLLARD

Class I IP55 IK08

Available in any of these RAL colors

7004	7016	9005	9016	6002	1015
------	------	------	------	------	------

EMFA's Ani Bollard combines a die-cast aluminium head housing an LED unit with an extrusion aluminium pipe. The bollard is designed to light pathways, landscapes and open spaces. The Ani bollard gives light only in the downward direction. This avoids any kind of glare and light pollution. The head and pipe are connected by a hidden screw within the pipe. The head contains LEDs that can be powered up to 12W. An optional galvanized steel anchorage kit is available for mounting into concrete. An alternative option is sleeve anchors for mounting onto existing concrete or a picket to mount into the earth.

Profile

Aluminium

Body

Die cast aluminium

Gaskets

Silicone

Diffusers

4 mm Tempered Glass

Screws

316L Stainless steel

Glands

PG 11

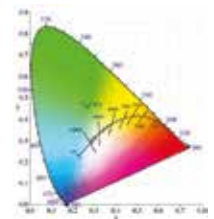

“Customization” is EMFA’s standard

EMFA offers many combinations for each fixture, as all fixtures are made in house. A combination of 6 standard paint colors, 8 LED colors, and 2 wattages, are available to make the fixture suitable for the required application. This is done without increasing lead-time and is available for large as well as small quantities.

Symmetrical

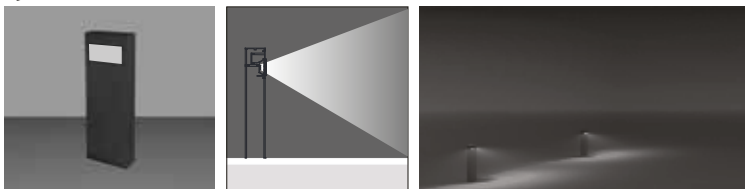

Asymmetrical

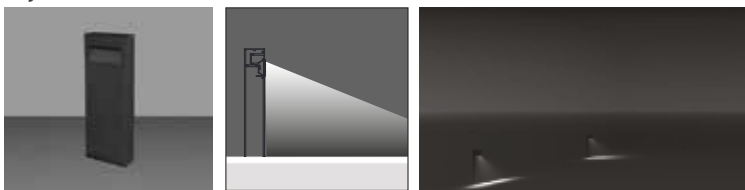

Asym. Glass



Trenched Glass



Milky Glass



Clear Glass



LEDs

Only highest quality LEDs such as Cree or Toplite are used in production allowing for maximum lumen output and maximum lifetime. Most LEDs run on 350mA or 700mA depending on how much light output is required. The white color temperature binning is 200K at most, and always on the same x,y coordinates on the CIE diagram in accordance with Energy Star. This ensures consistent supply of the same color temperature over time. As LEDs are constantly developing and becoming more efficient, lumen output given in this catalogue are current as of March 2020. At 2700K, 3000K, and 4000K LED lumen output per led is 100lm; at 6000K the lumen output per led is 125lm. Total Lighting Output as printed in this catalogue is the actual light output of the entire fixture. The minimum CRI of the LEDs used is 85 with a majority of products over 90.

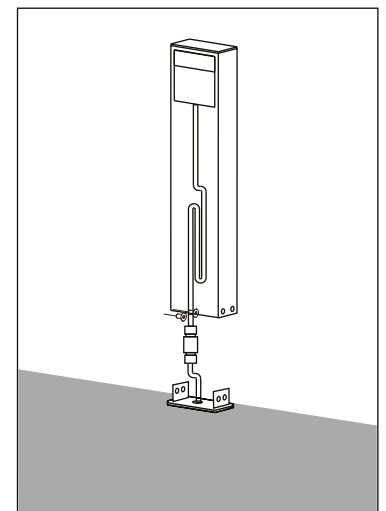

ANI 4 ALUM LED BOLLARD

Class I IP55 IK08

Available in any of these RAL colors

7004	7016	9005	9016	6002	1015
------	------	------	------	------	------

Symmetrical

- Led** : Linear LEDs
- Voltage** : 240 VAC with integrated driver
(12-24 VDC on request)
- Diffuser** : 4mm Tempered Glass
- Beam Angle** : 45° / 60° / 90°
- Mac Adam** : 3
- CRI** : >80
- L.O.R %** : %70



450mm			Real Lumen Output	Nominal Lumen Output
Power	Code No	Kelvin		
24W	459001	☀ 3000 K	1780 lm	2550 lm
48W	459011	☀ 3000 K	3080 lm	4300 lm
24W	459002	☾ 4000 K	2047 lm	2932 lm
48W	459012	☾ 4000 K	3542 lm	5060 lm

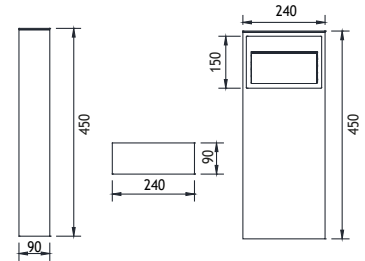

700mm			Real Lumen Output	Nominal Lumen Output
Power	Code No	Kelvin		
24W	459101	☀ 3000 K	1780 lm	2550 lm
48W	459111	☀ 3000 K	3080 lm	4300 lm
24W	459102	☾ 4000 K	2047 lm	2932 lm
48W	459112	☾ 4000 K	3542 lm	5060 lm

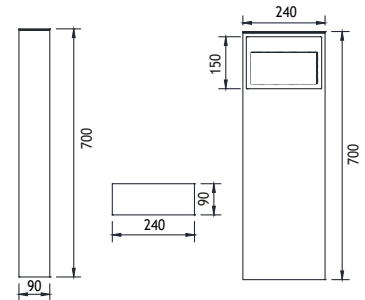

1100mm			Real Lumen Output	Nominal Lumen Output
Power	Code No	Kelvin		
24W	459201	☀ 3000 K	1780 lm	2550 lm
48W	459211	☀ 3000 K	3080 lm	4300 lm
24W	459202	☾ 4000 K	2047 lm	2932 lm
48W	459212	☾ 4000 K	3542 lm	5060 lm

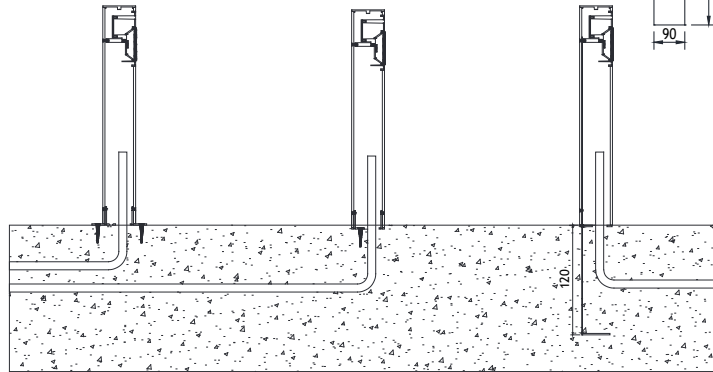
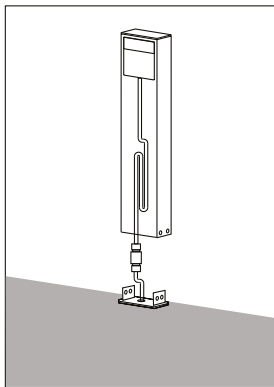
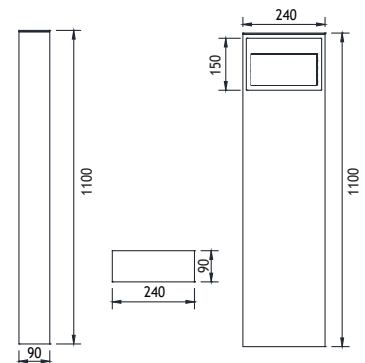

Concrete Mounting Step

Concrete Mounting Flush

Galvanized Steel Anchor

ANI 4 ALUM LED BOLLARD

Class I IP55 IK08

Available in any of these RAL colors

7004	7016	9005	9016	6002	1015
------	------	------	------	------	------

Asymmetrical

- Led** : Linear LEDs
- Voltage** : 240 VAC with integrated driver
(12-24 VDC on request)
- Diffuser** : 4mm Tempered Glass
- Beam Angle** : 45° / 60° / 90°
- Mac Adam** : 3
- CRI** : >80
- L.O.R %** : %70

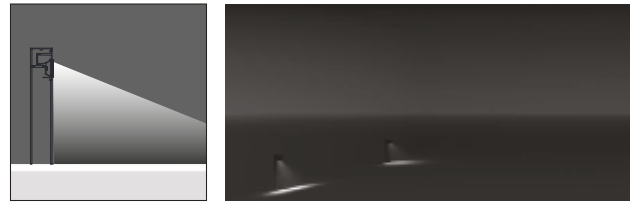

Power	Code No	Kelvin	Real Lumen Output	Nominal Lumen Output
24W	459501	3000 K	1780 lm	2550 lm
48W	459511	3000 K	3080 lm	4300 lm
24W	459502	4000 K	2047 lm	2932 lm
48W	459512	4000 K	3542 lm	5060 lm

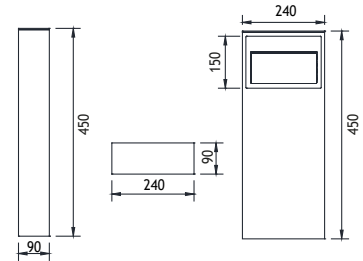

Power	Code No	Kelvin	Real Lumen Output	Nominal Lumen Output
24W	459601	3000 K	1780 lm	2550 lm
48W	459611	3000 K	3080 lm	4300 lm
24W	459602	4000 K	2047 lm	2932 lm
48W	459612	4000 K	3542 lm	5060 lm

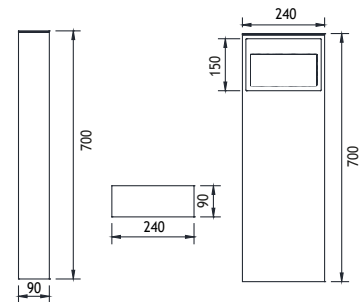

Power	Code No	Kelvin	Real Lumen Output	Nominal Lumen Output
24W	459701	3000 K	1780 lm	2550 lm
48W	459711	3000 K	3080 lm	4300 lm
24W	459702	4000 K	2047 lm	2932 lm
48W	459712	4000 K	3542 lm	5060 lm

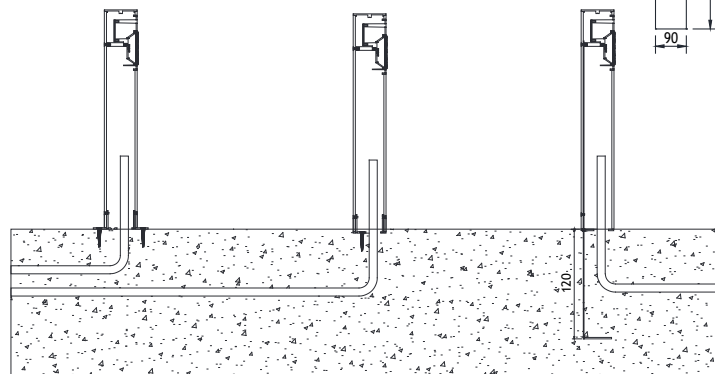
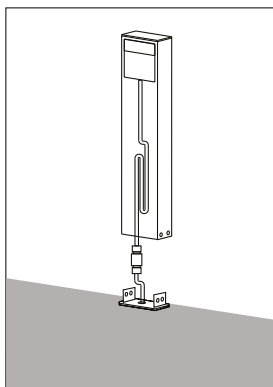
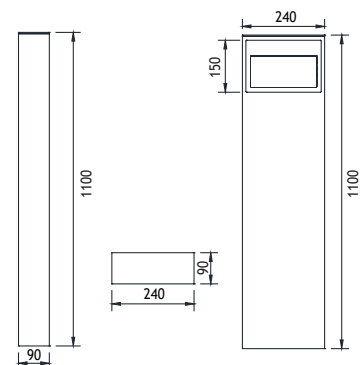

Concrete Mounting Step

Concrete Mounting Flush

Galvanized Steel Anchor



ANI 4 SIDE ALUM LED POLE

Class I IP65 IK08

Available in any of these RAL colors

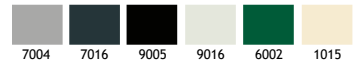

- Led** : Linear LEDs
- Voltage** : 240 VAC with integrated driver
(12-24 VDC on request)
- Diffuser** : 4mm Tempered Glass
- Beam Angle** : 45° / 60° / 90°
- Mac Adam** : 3
- CRI** : >80
- L.O.R %** : %70



2000mm

Power	Code No	Kelvin	Real Lumen Output	Nominal Lumen Output
24W	460001	3000 K	1780 lm	2550 lm
48W	460011	3000 K	3080 lm	4300 lm
24W	460002	4000 K	2047 lm	2932 lm
48W	460012	4000 K	3542 lm	5060 lm

4000mm

Power	Code No	Kelvin	Real Lumen Output	Nominal Lumen Output
24W	460101	3000 K	1780 lm	2550 lm
48W	460111	3000 K	3080 lm	4300 lm
24W	460102	4000 K	2047 lm	2932 lm
48W	460112	4000 K	3542 lm	5060 lm

6000mm

Power	Code No	Kelvin	Real Lumen Output	Nominal Lumen Output
24W	460201	3000 K	1780 lm	2550 lm
48W	460211	3000 K	3080 lm	4300 lm
24W	460202	4000 K	2047 lm	2932 lm
48W	460212	4000 K	3542 lm	5060 lm

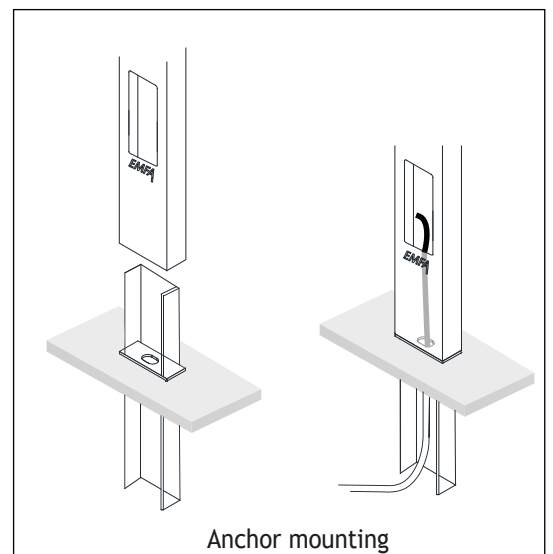
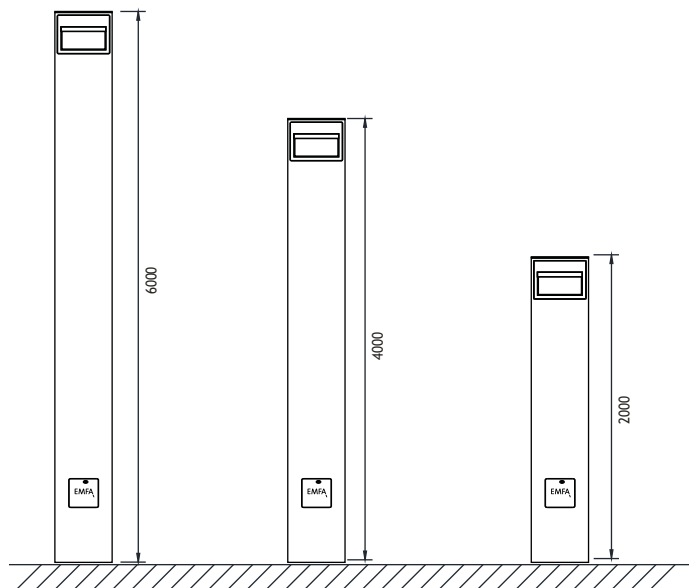
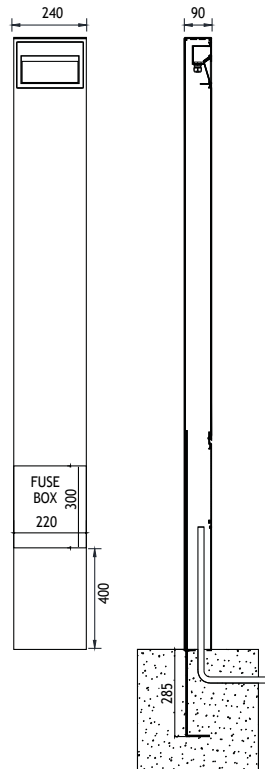

MILET ANI

SIDE ALUM LED POLE

Class I IP65 IK08

Available in any of these RAL colors

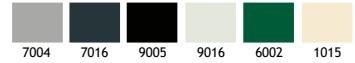

EMFA's ANI pole mounted series have been designed for high efficiency and ease of installation incorporating the latest in LED technology and control systems. The special lens directs the light flow precisely and makes the whole luminaire system efficient. This compact and essential design is made of a combination of aluminium profile and die cast aluminium.

Pole

Aluminium profile

Body

Die cast aluminium

Gaskets

Silicone

Diffusers

4 mm Tempered Glass

Screws

316L Stainless Steel

Glands

PG 11

“Customization” is EMFA’s standard

EMFA offers many combinations for each fixture, as all fixtures are made in house. A combination of 6 standard paint colors, 8 LED colors, and 2 wattages, and available to make the fixture suitable for the required application. This is done without increasing lead-time and is available for large as well as small quantities.

Asymmetrical

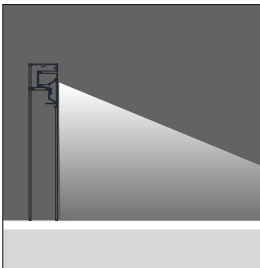

Anchor

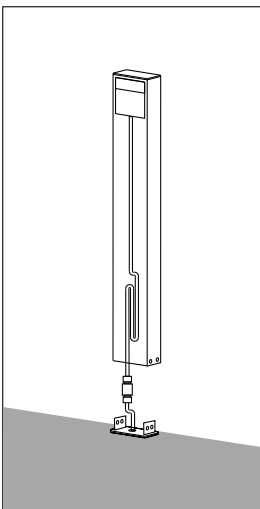

Fuse Box







LEDs

Only highest quality LEDs such as Cree or Toplite are used in production allowing for maximum lumen output and maximum lifetime. Most LEDs run on 350mA or 700mA depending on how much light output is required. The white color temperature binning is 200K at most, and always on the same x,y coordinates on the CIE diagram in accordance with Energy Star. This ensures consistent supply of the same color temperature over time. As LEDs are constantly developing and becoming more efficient, lumen output given in this catalogue are current as of March 2020. At 2700K, 3000K, and 4000K LED lumen output per led is 110lm; at 6000K the lumen output per led is 125lm. Total Lighting Output as printed in this catalogue is the actual light output of the entire fixture. The minimum CRI of the LEDs used is 85 with a majority of products over 90.

ANI 4 L TYPE ALUM LED POLE

Class I IP65 IK08

Available in any of these RAL colors

					
7004	7016	9005	9016	6002	1015

EMFA's ANI pole mounted series have been designed for high efficiency and ease of installation incorporating the latest in LED technology and control systems. The special lens directs the light flow precisely and makes the whole luminaire system efficient. This compact and essential design is made of a combination of aluminium profile and die cast aluminium.

Pole

Aluminium profile

Body

Die cast aluminium

Gaskets

Silicone

Diffusers

4 mm Tempered Glass

Screws

316L Stainless Steel

Glands

PG 11

“Customization” is EMFA’s standard

EMFA offers many combinations for each fixture, as all fixtures are made in house. A combination of 6 standard paint colors, 8 LED colors, and 2 wattages, and available to make the fixture suitable for the required application. This is done without increasing lead-time and is available for large as well as small quantities.



Asymmetrical

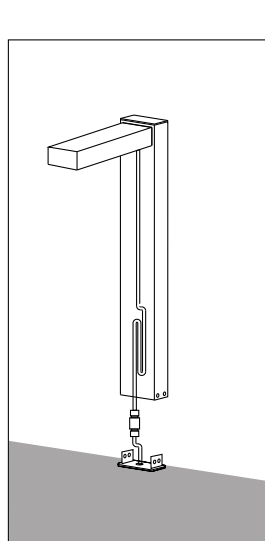
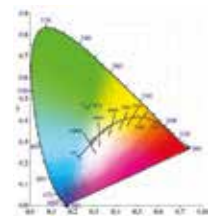
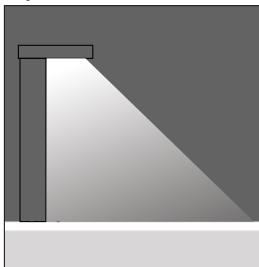

LEDs

Only highest quality LEDs such as Cree or Toplite are used in production allowing for maximum lumen output and maximum lifetime. Most LEDs run on 350mA or 700mA depending on how much light output is required. The white color temperature binning is 200K at most, and always on the same x,y coordinates on the CIE diagram in accordance with Energy Star. This ensures consistent supply of the same color temperature over time. As LEDs are constantly developing and becoming more efficient, lumen output given in this catalogue are current as of March 2020. At 2700K, 3000K, and 4000K LED lumen output per led is 110lm; at 6000K the lumen output per led is 125lm. Total Lighting Output as printed in this catalogue is the actual light output of the entire fixture. The minimum CRI of the LEDs used is 85 with a majority of products over 90.

ANI 4 L TYPE ALUM LED POLE

Class I IP65 IK08

Available in any of these RAL colors

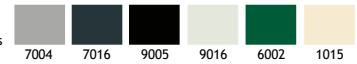

- Led** : Linear LEDs
- Voltage** : 240 VAC with integrated driver
(12-24 VDC on request)
- Diffuser** : 4mm Tempered Glass
- Beam Angle** : 45° / 60° / 90°
- Mac Adam** : 3
- CRI** : >80
- L.O.R %** : %70



2000mm			Real Lumen Output	Nominal Lumen Output
Power	Code No	Kelvin		
24W	461001	3000 K	1780 lm	2550 lm
48W	461011	3000 K	3080 lm	4300 lm
24W	461002	4000 K	2047 lm	2932 lm
48W	461012	4000 K	3542 lm	5060 lm

4000mm			Real Lumen Output	Nominal Lumen Output
Power	Code No	Kelvin		
24W	461101	3000 K	1780 lm	2550 lm
48W	461111	3000 K	3080 lm	4300 lm
24W	461102	4000 K	2047 lm	2932 lm
48W	461112	4000 K	3542 lm	5060 lm

6000mm			Real Lumen Output	Nominal Lumen Output
Power	Code No	Kelvin		
24W	461201	3000 K	1780 lm	2550 lm
48W	461211	3000 K	3080 lm	4300 lm
24W	461202	4000 K	2047 lm	2932 lm
48W	461212	4000 K	3542 lm	5060 lm

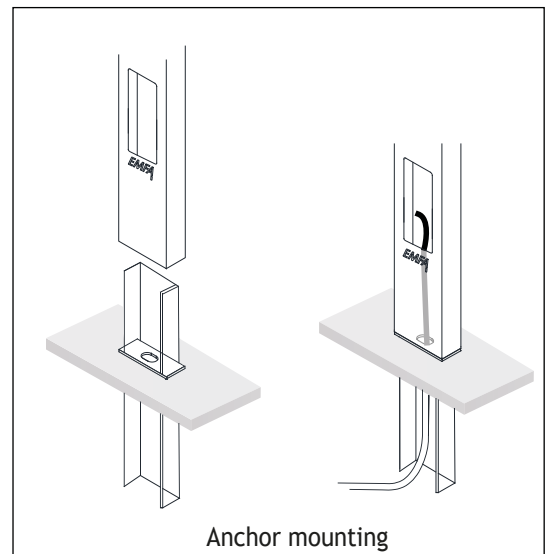
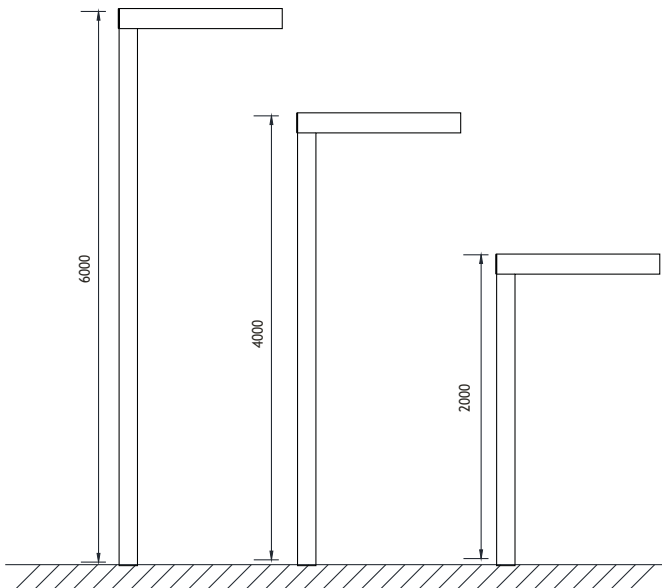
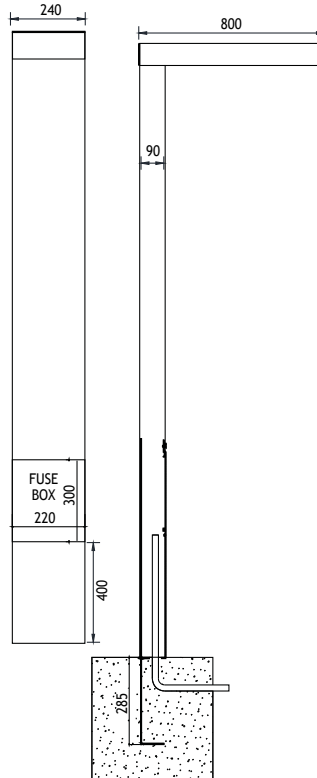

ANI 4 T TYPE ALUM LED POLE

Class I IP65 IK08

Available in any of these RAL colors

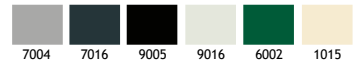

EMFA's ANI pole mounted series have been designed for high efficiency and ease of installation incorporating the latest in LED technology and control systems. The special lens directs the light flow precisely and makes the whole luminaire system efficient. This compact and essential design is made of a combination of aluminium profile and die cast aluminium.

Pole

Aluminium profile

Body

Die cast aluminium

Gaskets

Silicone

Diffusers

4 mm Tempered Glass

Screws

316L Stainless Steel

Glands

PG 11

“Customization” is EMFA’s standard

EMFA offers many combinations for each fixture, as all fixtures are made in house. A combination of 6 standard paint colors, 8 LED colors, and 2 wattages, and available to make the fixture suitable for the required application. This is done without increasing lead-time and is available for large as well as small quantities.



Asymmetrical

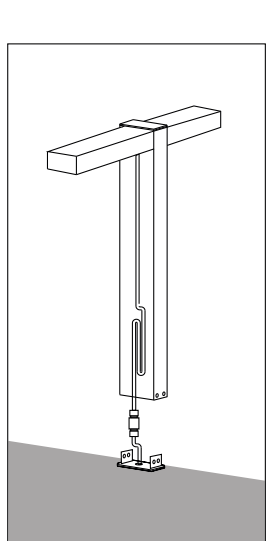
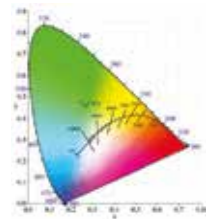
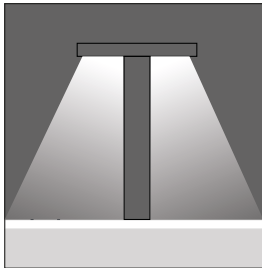

Anchor



Fuse Box



LEDs

Only highest quality LEDs such as Cree or Toplite are used in production allowing for maximum lumen output and maximum lifetime. Most LEDs run on 350mA or 700mA depending on how much light output is required. The white color temperature binning is 200K at most, and always on the same x,y coordinates on the CIE diagram in accordance with Energy Star. This ensures consistent supply of the same color temperature over time. As LEDs are constantly developing and becoming more efficient, lumen output given in this catalogue are current as of March 2020. At 2700K, 3000K, and 4000K LED lumen output per led is 110lm; at 6000K the lumen output per led is 125lm. Total Lighting Output as printed in this catalogue is the actual light output of the entire fixture. The minimum CRI of the LEDs used is 85 with a majority of products over 90.

ANI 4 T TYPE ALUM LED POLE

Class I IP65 IK08

Available in any of these RAL colors

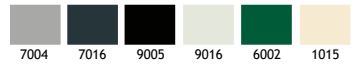

- Led** : Linear LEDs
- Voltage** : 240 VAC with integrated driver
(12-24 VDC on request)
- Diffuser** : 4mm Tempered Glass
- Beam Angle** : 45° / 60° / 90°
- Mac Adam** : 3
- CRI** : >80
- L.O.R %** : %70



2000mm			Real Lumen Output	Nominal Lumen Output
Power	Code No	Kelvin		
2x24W	462001	3000 K	1780 lm	2550 lm
2x48W	462011	3000 K	3080 lm	4300 lm
2x24W	462002	4000 K	2047 lm	2932 lm
2x48W	462012	4000 K	3542 lm	5060 lm

4000mm			Real Lumen Output	Nominal Lumen Output
Power	Code No	Kelvin		
2x24W	462101	3000 K	1780 lm	2550 lm
2x48W	462111	3000 K	3080 lm	4300 lm
2x24W	462102	4000 K	2047 lm	2932 lm
2x48W	462112	4000 K	3542 lm	5060 lm

6000mm			Real Lumen Output	Nominal Lumen Output
Power	Code No	Kelvin		
2x24W	462201	3000 K	1780 lm	2550 lm
2x48W	462211	3000 K	3080 lm	4300 lm
2x24W	462202	4000 K	2047 lm	2932 lm
2x48W	462212	4000 K	3542 lm	5060 lm

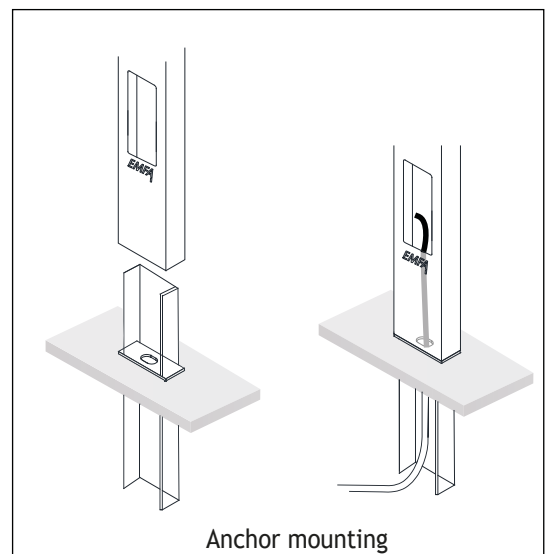
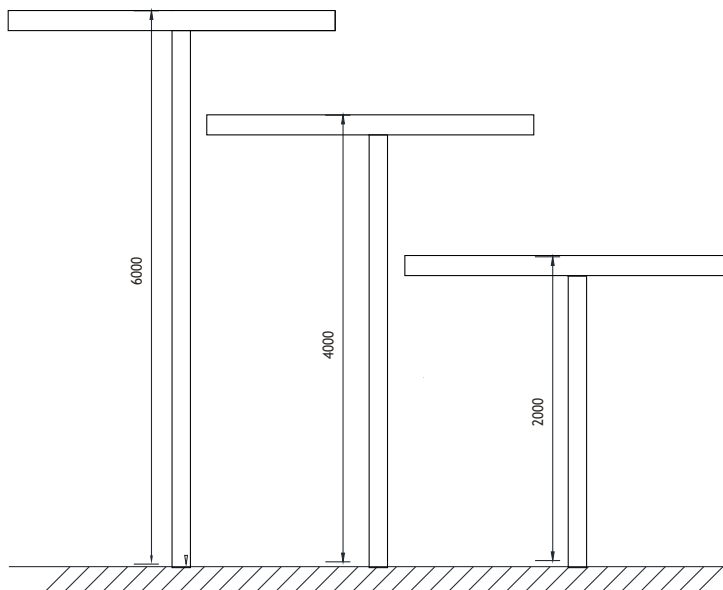

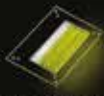

Driveover



Walkover



Wall recessed



Wall surface



Alum. bollard

ANI SERIES



Wall recessed



Wall surface



Wallwasher spot



Wallwasher spot

headquarters

EMFA
Elektrik Malzeme Fabrikasi A.S.

Davutpasa Caddesi
Cebealibey Sokak No. 18
34020 Topkapi / Istanbul
Turkey

tel: +90 212 4822962
fax: +90 212 4822781

emfa@emfa.com.tr

EMFA