

BELKIS MINI

LED HIGH SPOT LED DRIVER IN HADE Class I IP67 IK08

Available in any
of these RAL colors

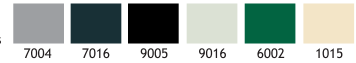

The Belkis Spot series consists of a range of LED, metal halide, fluorescent and halogen sources to deliver the desired light effect to facades, columns, bridges, monuments, signs, and trees. The series is made of die cast aluminium and painted with electrostatic powder paint. 6 standard RAL colors can be chosen from to adapt the spots to their environment (grey, anthracite, black, white, green and beige). The spots can be mounted on surfaces, in the ground or concrete with a picket, or on a pole with the addition of a simple adaptor. Two adaptors are available for two sizes of poles. Once installed, the special joint system allows for 100° horizontal and 180° vertical adjustment. The gearboxes are either filled with cast resin and have a pre-potted cable for IP67, or have a stainless steel cover and cable glands for IP55. The LEDs come in 3 different tones of white, as well as blue, red, green, amber and RGB. Several lenses from 6 to 40 degrees are available to choose from to achieve the desired the light effect.

Body

Die cast aluminium

Paint

Electrostatic powder

Gearbox Cover

Stainless steel

Gaskets

Silicone

Diffusers

Tempered Glass

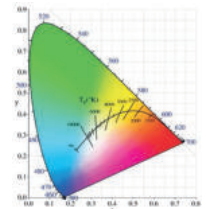
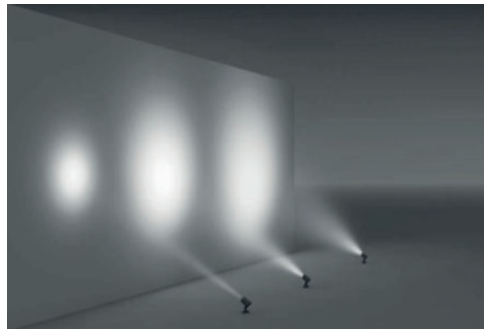
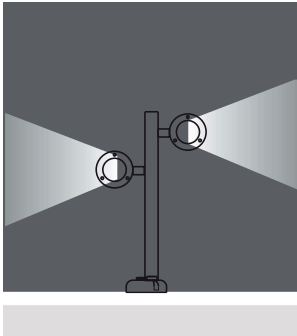
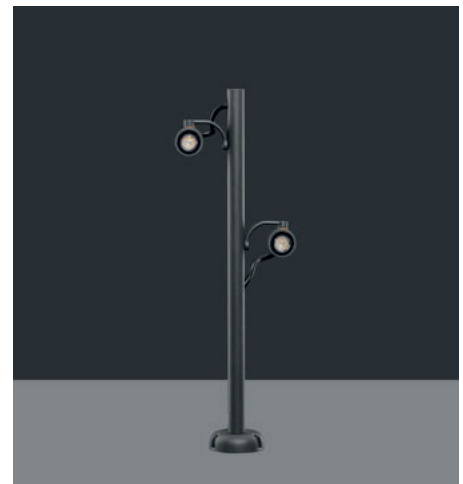

LEDs

Only highest quality LEDs such as Cree or Toplite are used in production allowing for maximum lumen output and maximum lifetime. Most LEDs run on 350mA or 700mA depending on how much light output is required. The white color temperature binning is 200K at most, and always on the same x,y coordinates on the CIE diagram in accordance with Energy Star. This ensures consistent supply of the same color temperature over time. As LEDs are constantly developing and becoming more efficient, lumen output given in this catalogue are current as of March 2020. At 2700K, 3000K, and 4000K LED lumen output per led is 110lm; at 6000K the lumen output per led is 125lm. Total Lighting Output as printed in this catalogue is the actual light output of the entire fixture. The minimum CRI of the LEDs used is 85 with a majority of products over 90.

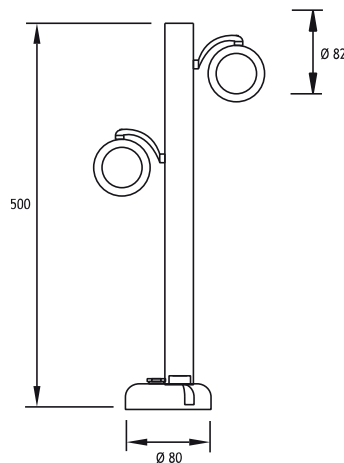

Picket

Code No: 953711



Visor

Code No: 953712

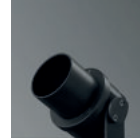

Cylinder Visor

Code No: 953713



Honeycomb

Code No: 953714

Voltage : 240V A.C with integrated driver
(24V AC or DC on request)

Lens : 10°, 25°, 40°

Diffuser : Clear Glass 8 mm (Frosted Glass on request)

Cable : Potted 5 m 3x0,75 H03 VV-F

3 x 350 mA (2x6 W) COB LED

12V - 24V (240V A.C with external driver)

Total
Lighting Output Code No
510 lm 297151

☀ Warm White 3000 K

Thermal Management

All fixtures are designed to withstand ambient temperatures of at least 50°C. The LEDs are mounted on metal core pcbs, which are mounted to the aluminium body of the fixture so that the entire fixture acts as a heat sink. Extensive testing is performed in EMFA's laboratory to ensure these values are maintained so that the lifetime of the LED is not compromised.