

GORDION RECESSED LED FIXTURES

Load 5 kN | Class I IP67 IK08

The Gordion series is an adaption of the Belkis Recessed series without the stainless steel cover. Merely a painted glass finishes the look of the fixture. Once placed inside the stainless steel tube, the fixture can only be removed with a special tool. The Gordion series is designed to light walls, facades, columns, monuments, and trees. The fixtures are made of die cast aluminium body painted with electrostatic powder paint. Tempered glass, silicone gaskets and cast resin complete the fixture to make it IP67 IK10 and withstand rough environments. A specially developed potted power cable is used to effectively bond with the cast resin and stop any water ingress. The LEDs used come in 3 different tones of white, as well as blue, red, green, amber and RGB. Several lenses from 6 to 40 degrees are available to choose from to achieve the desired light effect.

Body	Gaskets
Die cast aluminium	Silicone
Recessing Tube	Diffusers
316L Stainless steel	Tempered Glass with painted circumference



“Customization” is EMFA’s standard

EMFA offers many combinations for each fixture, as all fixtures are made in house. A combination of 2 finishes of stainless steel, 8 LED colors, 2 wattages, and 5 or more lenses and reflectors are available to make the fixture suitable for the required application. This is done without increasing lead-time and is available for large as well as small quantities.

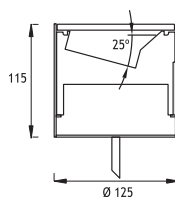
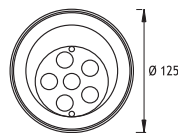
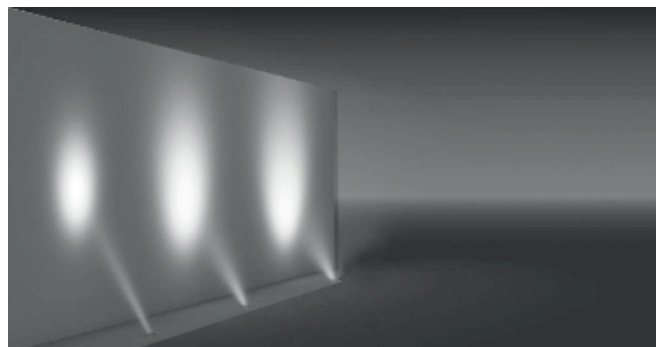
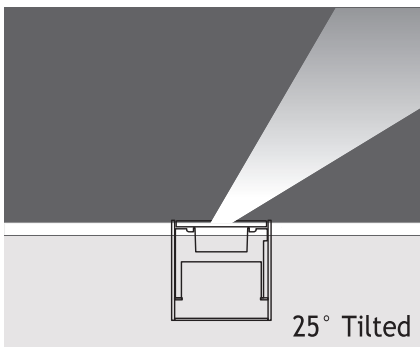

6 x 350 mA (6 W) LED	Total Lighting Output	Code No
RGB		170251

Single color LED options upon request are ;
 Blue Amber Green Red

LEDs

Only highest quality LEDs such as Cree or Toplite are used in production allowing for maximum lumen output and maximum lifetime. Most LEDs run on 350mA or 700mA depending on how much light output is required. The white color temperature binning is 200K at most, and always on the same x,y coordinates on the CIE diagram in accordance with Energy Star. This ensures consistent supply of the same color temperature over time. As LEDs are constantly developing and becoming more efficient, lumen output given in this catalogue are current as of March 2020. At 2700K, 3000K, and 4000K LED lumen output per led is 110lm; at 6000K the lumen output per led is 125lm. Total Lighting Output as printed in this catalogue is the actual light output of the entire fixture. The minimum CRI of the LEDs used is 85 with a majority of products over 90.

