

PATNOS RECESSED FIXTURES

IP67 IK10

The Patnos series is an adaption of the Belkis Recessed series using less or no visible screws. No screws are visible on the cover if silicone is used to glue the fixture to the recessing tube. The series is designed to light walls, facades, columns, monuments, and trees. The fixtures are made of a combination of a 316L stainless steel cover and die cast aluminium body painted with electrostatic powder paint. Tempered glass, silicone gaskets and cast resin complete the fixture to make it IP67 IK10 and withstand rough environments. A specially developed potted power cable is used to effectively bond with the cast resin and stop any water ingress. The fixtures come with an aluminium recessing tube for easy mounting in the ground or concrete. The LEDs used come in 3 different tones of white, as well as blue, red, green, amber and RGB. Several lenses from 6 to 40 degrees are available to choose from to achieve the desired light effect.

Cover	Gaskets
316L Stainless steel	Silicone
Body	Diffusers
Die cast aluminium	Tempered Glass
Recessing Box	Screws
Aluminium	316L Stainless steel



“Customization” is EMFA’s standard

EMFA offers many combinations for each fixture, as all fixtures are made in house. A combination of 2 finishes of stainless steel, 8 LED colors, 2 wattages, and 5 or more lenses and reflectors are available to make the fixture suitable for the required application. This is done without increasing lead-time and is available for large as well as small quantities.

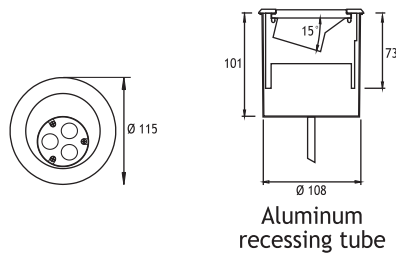
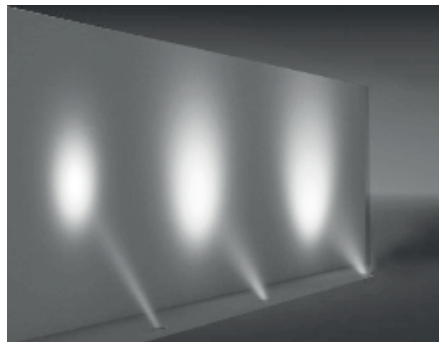
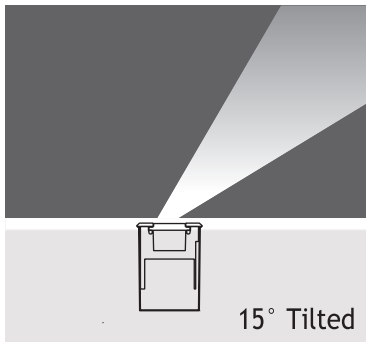

LEDs

Only highest quality LEDs such as Cree or Toplite are used in production allowing for maximum lumen output and maximum lifetime. Most LEDs run on 350mA or 700mA depending on how much light output is required. The white color temperature binning is 200K at most, and always on the same x,y coordinates on the CIE diagram in accordance with Energy Star. This ensures consistent supply of the same color temperature over time. As LEDs are constantly developing and becoming more efficient, lumen output given in this catalogue are current as of March 2020. At 2700K, 3000K, and 4000K LED lumen output per led is 110lm; at 6000K the lumen output per led is 125lm. Total Lighting Output as printed in this catalogue is the actual light output of the entire fixture. The minimum CRI of the LEDs used is 85 with a majority of products over 90.

Thermal Management

All fixtures are designed to withstand ambient temperatures of at least 50°C. The LEDs are mounted on metal core pcbs, which are mounted the aluminium body of the fixture so that the entire fixture acts as a heat sink. Extensive testing is performed in EMFA’s laboratory to ensure these values are maintained so that the lifetime of the LED is not compromised.

		Total Lighting Output		3W Round	9W Round
		3W	9W		
☀ Warm White	3000 K	255 lm	675 lm	161321	161361