

MIRA SURFACE MOUNTED FIXTURES

Class I IP67 IK10

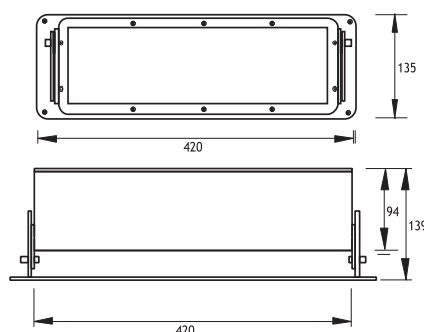

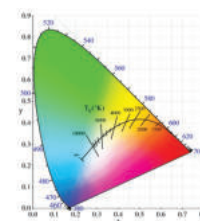
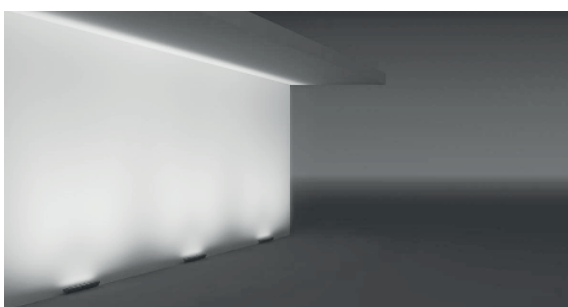
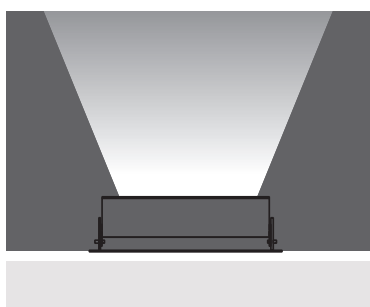

The Mira series consists of a range of LED, fluorescent and metal halide sources to deliver the desired light effect to facades, columns, bridges, monuments, and signs. The series is made of a die cast aluminium body with electrostatic powder paint finished with a 316L stainless steel cover. The recessed versions are for drive over up to 20 kN including a stainless steel recessing box. The surface mounted versions come with a heavy-duty 316L stainless steel bracket. The fixtures come with integrated electronic ballasts and a specially developed potted power cable to effectively bond with the cast resin and stop any water ingress. The LEDs used come in 3 different tones of white, as well as blue, red, green, amber and RGB. Several lenses from 6 to 40 degrees are available to choose from to achieve the desired light effect.

Cover	Diffusers	Screws
316L Stainless steel	12 mm Tempered Glass	316L Stainless steel
Body	Gaskets	Recessing Box
Die cast aluminium	Silicone	Stainless steel



Voltage	: 240V AC with integrated driver (24V AC or DC on request)
Lens	: 10°, 25°, 40°
Diffuser	: Clear Glass 12 mm (Frosted Glass on request)
Cable	: Potted 5 m 3x0,75 H03 VV-F

81 x 350 mA (81 W) RGB LED	Code No
 RGB	430821

Single color LED options upon request are ;
 Blue  Amber  Green  Red

LEDs

Only highest quality LEDs such as Cree or Toplite are used in production allowing for maximum lumen output and maximum lifetime. Most LEDs run on 350mA or 700mA depending on how much light output is required. The white color temperature binning is 200K at most, and always on the same x,y coordinates on the CIE diagram in accordance with Energy Star. This ensures consistent supply of the same color temperature over time. As LEDs are constantly developing and becoming more efficient, lumen output given in this catalogue are current as of March 2020. At 2700K, 3000K, and 4000K LED lumen output per led is 110lm; at 6000K the lumen output per led is 125lm. Total Lighting Output as printed in this catalogue is the actual light output of the entire fixture. The minimum CRI of the LEDs used is 85 with a majority of products over 90.

Thermal Management

All fixtures are designed to withstand ambient temperatures of at least 50°C. The LEDs are mounted on metal core pcbs, which are mounted the aluminium body of the fixture so that the entire fixture acts as a heat sink. Extensive testing is performed in EMFA's laboratory to ensure these values are maintained so that the lifetime of the LED is not compromised.